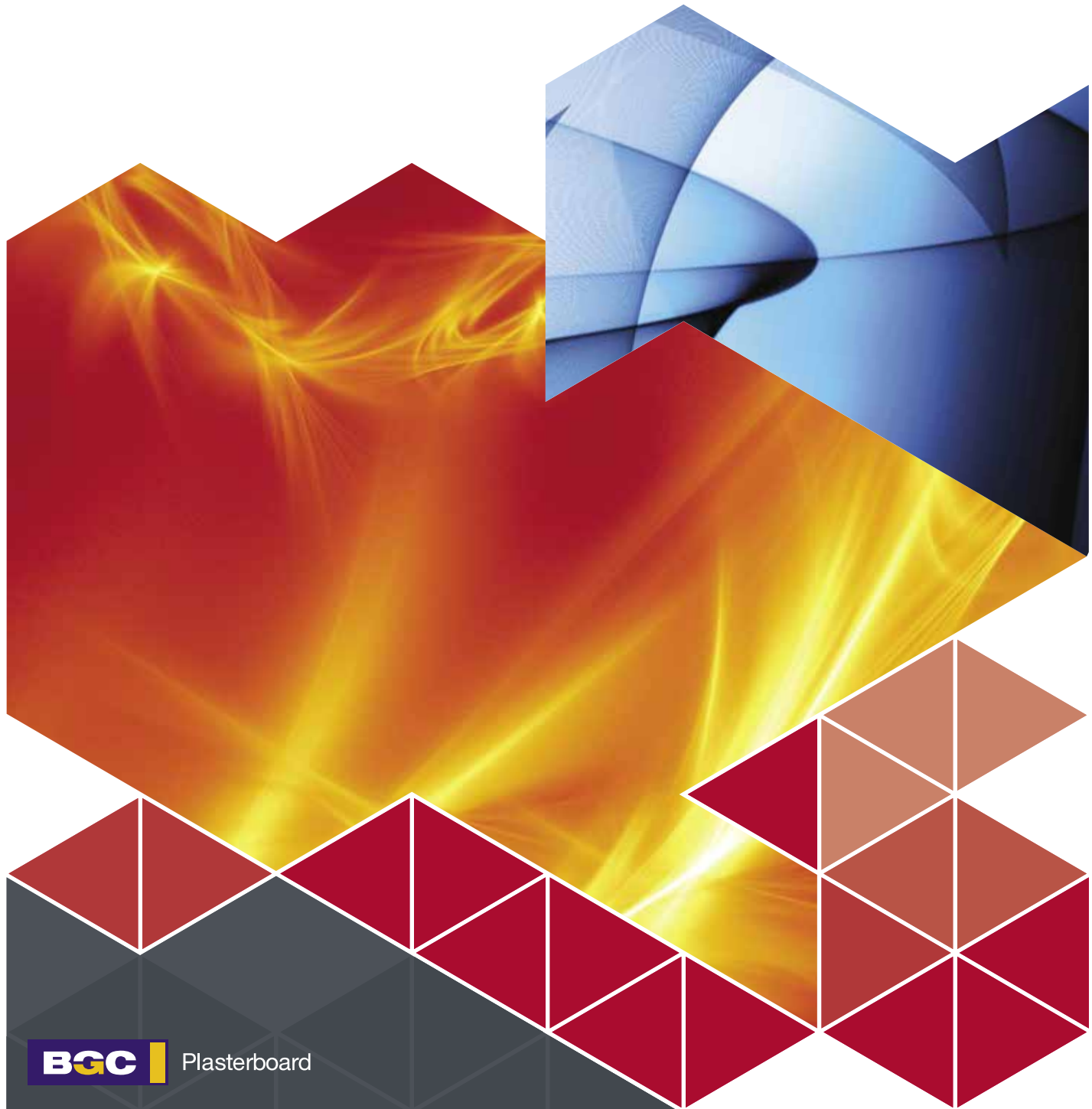




**GTEK™ FIRE & ACOUSTIC GUIDE**



**BGC** | Plasterboard

BGC Fibre Cement and Plasterboard is a proudly Australian based company that produces fibre cement and plasterboard products for Australia and for export.

#### WHY GTEK™?

WITH OUR ALL-AUSTRALIAN GTEK™ RANGE OF INTERIOR LINING PRODUCTS, YOU BENEFIT FROM SUSTAINABLE, QUALITY-TESTED TECHNOLOGY, FULL BGC INTERIOR LINING SYSTEMS COMPATIBILITY AND OUR CLASS-LEADING SERVICE NETWORK.

- ▶ **TECHNOLOGY** / Light, modular GTEK™ technology eases installation for seamless results
- ▶ **SUSTAINABILITY** / GECA certified: sustainable manufacture means higher Green Star ratings for your building
- ▶ **AUSTRALIAN MADE** / All-Australian: closest available links between local manufacture and supply
- ▶ **SERVICE** / Vast distribution network assures best-in-class service delivery
- ▶ **QUALITY** / Independent testing accords with Australia's toughest build-quality accreditations
- ▶ **SYSTEMS** / Full compatibility with extensive BGC interior lining systems range



## INTRODUCTION

The GTEK™ Fire and Acoustic Guide has been designed to assist architects, specifiers, designers, builders and contractors in the selection of the correct system for projects when fire and acoustic properties are required.

Each of the systems in this Guide has been given a unique system number to help with ease of identification. A quick reference guide to these numbers is noted further in the Guide.

The data contained in this Guide meets all Australian standards and is correct at the time of publication.

**SAFETY**

In normal circumstances there are no known health hazards when using or applying plasterboard. However, BGC Plasterboard recommends that the following precautions are followed.

Avoid creating dust when handling GTEK™ products. BGC Plasterboard suggests that P1 or P2 particulate respirator (dust mask), which comply with Australian and New Zealand Standard AS/NZS 1715: Selection, Use and Maintenance of Respiratory Protective Devices, and Australian and New Zealand Standard AS/NZS 1716: Respiratory Protective Devices when Exposed to Dust), be used at all times.

**FIRST AID**

**Eyes** Flush with clean water for 15 minutes. Seek medical attention if irritation persists.

**Skin** Wash with mild soap and water. Seek medical attention if irritation persists.

**Inhalation** Drink plenty of water. Seek medical attention.

Material Safety Data Sheets for GTEK™ and BGC Fibre Cement products are available at any BGC state office or the BGC websites

[gtekplasterboard.com.au](http://gtekplasterboard.com.au)  
[bgcinnovadesign.com.au](http://bgcinnovadesign.com.au)

**CERTIFICATION DETAILS**

All systems in the GTEK™ Fire and Acoustic Guide have been assessed to meet all requirements of Australian Standards and the National Construction Code.

Acoustic testing has been carried out to Australian Standards.

The acoustic testing has been carried out by the following institutions:

- ▶ Royal Melbourne Institute of Technology (RMIT)
- ▶ CSIRO

The fire testing has been carried out to Australian Standard AS1530 – part 4 ‘Fire and Resistance Tests of Elements of Building Construction’ and were carried out by:

- ▶ CSIRO
- ▶ Exova Warringtonfire Aus Pty Ltd.

Fire and acoustic test reports and opinions can be obtained upon request. The systems detailed in this Guide and their warranties are only valid if constructed in accordance with GTEK™ or BGC Fibre Cement installation methods and using only GTEK™ or BGC Fibre Cement products.

BGC manufactures plasterboard and fibre cement products under the rigorous Quality Management System of the International Standard ISO 9001:2015 and is the holder of Licence Agreement numbers QEC 2955/13 and QEC 29633.

GTEK™ SHEET SIZES AND WEIGHTS

PRODUCT AND THICKNESS (mm)	WEIGHT (kg/m <sup>2</sup> )	WIDTH (mm)	LENGTH (mm)							
			2400	2700	3000	3600	4200	4800	5400	6000
GTEK™ Wall 10mm	6.1	1200	✓	✓	✓	✓	✓	✓	✓	✓
		1350				✓	✓	✓		✓
GTEK™ Wall 13mm	8.2	1200	✓	✓	✓	✓	✓	✓		✓
		1350			✓	✓	✓	✓		
GTEK™ Ceiling 10mm	6.1	1200	✓	✓	✓	✓	✓	✓	✓	✓
		1350	✓		✓	✓	✓	✓		✓
GTEK™ Wet Area 10mm	7.8	1200	✓	✓	✓	✓	✓	✓		
		1350	✓		✓	✓	✓	✓		
GTEK™ Wet Area 13mm	9.2	1200	✓	✓	✓	✓	✓			
		1350			✓	✓	✓			
GTEK™ Fire 13mm	10.4	1200	✓	✓	✓	✓				
		1350				✓				
GTEK™ Fire 16mm	12.6	1200	✓	✓	✓	✓				
		1350				✓				
GTEK™ Fire & Wet Area 13mm	10.4	1200				✓				
GTEK™ Fire & Wet Area 16mm	12.6	1350				✓				
GTEK™ Sound 10mm	8.4	1200			✓	✓		✓		
		1350				✓		✓		
GTEK™ Sound 13mm	11.7	1200			✓	✓				
		1350				✓				
GTEK™ Curve 6.5mm	4.5	1350				✓				
GTEK™ Impact 13mm	11.7	1200			✓	✓				
		1350				✓				
GTEK™ Total Plus 13mm	11.7	1200				✓				
		1350				✓				
Cove Cornice 55	0.65	55			✓	✓	✓	✓		
Cove Cornice 75	0.95	75			✓	✓	✓	✓		
Cove Cornice 90	1.25	90			✓	✓	✓	✓		
Esperance Cornice 75	0.95	75						✓		

GTEK™ COMPOUNDS AND ADHESIVES

PRODUCT	BUCKET/BAG SIZE
Stud Adhesive	1.25kg
Stud Adhesive	5.2kg
Water Resistant Taping Cement	1.65kg
Water Resistant Taping Cement	6.4kg
All Purpose Lightweight	20kg
Top Coat	20kg
Base Coat 45	20kg
Base Coat 60	20kg
Base Coat 90	20kg
Cornice Cement 45	20kg
Cornice Cement 60	20kg
Cornice Cement 90	20kg
Masonry Adhesive	20kg
Back Blocking Cement	20kg
Fibreglass Tape	50mm x 20m
Fibreglass Tape	50mm x 90m

BGC PRODUCTS – BGC INNOVA

PRODUCT AND THICKNESS (MM)	WEIGHT (KG/M <sup>2</sup> )	WIDTH (MM)	LENGTH (MM)																						
			1190	1200	1500	1790	1800	2100	2250	2390	2400	2440	2450	2700	2725	2750	2990	3000	3600	4200	4800	5400	6000		
Duragrid™ 9mm	13.5	1190	✓														✓								
		890			✓																				
		590								✓															
Duracom™ 9mm	14.6	1200				✓				✓			✓					✓							
		900			✓					✓									✓						
Duracom™ 12mm	19.5	1200								✓									✓						
Durascape™ 9mm	13.5	1200											✓						✓						
		900											✓						✓						
Duragroove™ Smooth Narrow 9mm	13.5	1200											✓				✓		✓						
Duragroove™ Smooth Wide 9mm	13.5	1200											✓				✓		✓						
Duragroove™ Smooth Extra Wide 9mm	13.5	1200											✓				✓		✓						
Duragroove™ Woodgrain 9mm	13.5	1200											✓				✓		✓						
Stratum™ 12mm																							✓		
Stratum™ Duo 12mm	5.2	300																					✓		
Stratum™ Trio 12mm																							✓		
Stratum™ Contour 10mm	2.5	170																					✓		
Stratum™ Era 10mm	4.1	295																					✓		
Nuline™ Plus Square 14mm	4.2	205																					✓		
	3.5	175																					✓		
Nuline™ Plus Bullnose 14mm	4.2	205																					✓		
	3.5	175																					✓		
Stonesheet 9mm	13.2	1200																					✓		

BGC PRODUCTS – BGC FIBRE CEMENT

PRODUCT AND THICKNESS (MM)	WEIGHT (KG/M <sup>2</sup> )	WIDTH MM	LENGTH																				
			1190	1200	1500	1790	1800	2100	2250	2390	2400	2440	2450	2700	2725	2750	2990	3000	3600	4200	4800	5400	6000
Durafloor™ 19mm	26.2	600						✓					✓										
		1200					✓	✓			✓		✓					✓					
Durasheet™ 4.5mm	6.6	900					✓				✓		✓				✓						
		750									✓												
		600									✓												
		450									✓												
Durasheet™ 6mm	8.8	1200					✓				✓		✓				✓						
		900									✓							✓					
Duraplank™ 7.5mm Smooth and Woodgrain	3.3	300																			✓		
Duraplank™ 7.5mm Rusticated	2.5	230																			✓		
	2.2	205																			✓		
Duratex™ 7.5mm	10.9	1200					✓					✓		✓			✓						
		900										✓		✓			✓						
Duratex™ 9mm	13	1200										✓					✓						
Duralattice™ 6mm	7	1200					✓					✓											
		900										✓											
Duraliner™ Plus 6mm	8.9	900										✓						✓					
		1200										✓		✓				✓	✓	✓			
Duraliner™ Plus 9mm	13.2	1350										✓						✓	✓	✓			
		1200										✓		✓				✓	✓				
Duraliner™ Plus 12mm	17.9	1200																✓	✓				
Duralux™ Plus 4.5mm*	6.8	1200										✓		✓				✓	✓				
		900																✓					
Duralux™ Plus 6mm	8.9	1200										✓		✓				✓	✓				
		900																✓					
Duralux™ Plus 9mm	13.2	1200										✓		✓				✓					
Compressed Flooring 15mm	26	1200			✓		✓	✓				✓		✓				✓					
		900			✓		✓	✓				✓		✓				✓					
Compressed Flooring 18mm	31.1	1200			✓		✓	✓				✓						✓					
		900			✓		✓					✓						✓					
Compressed Flooring 24mm	41.2	1200										✓											
Ceramic Tile Underlay 6mm	8.8	1200					✓																
		900					✓																
Vinyl and Cork Underlay 5mm	7.5	900		✓																			

\* Available only in Queensland

QUICK REFERENCE GUIDE

STEEL FRAME – SINGLE STUD

SIDE 1	SIDE 2	FRL	SYSTEM NUMBER	PAGE NO.
1 x 10mm GTEK™ Wall	1 x 10mm GTEK™ Wall	-/-/-	GTEK-S001	31
1 x 13mm GTEK™ Wall	1 x 13mm GTEK™ Wall	-/-/-	GTEK-S002	31
2 x 13mm GTEK™ Wall	1 x 13mm GTEK™ Wall	-/-/-	GTEK-S003	31
2 x 13mm GTEK™ Wall	2 x 13mm GTEK™ Wall	-/-/-	GTEK-S005	32
1 x 10mm GTEK™ Sound	1 x 10mm GTEK™ Sound	-/-/-	GTEK-S006	32
1 x 13mm GTEK™ Sound	1 x 13mm GTEK™ Sound	-/-/-	GTEK-S007	32
2 x 10mm GTEK™ Sound	1 x 10mm GTEK™ Wet Area	-/-/-	GTEK-S009	33
2 x 10mm GTEK™ Sound	2 x 10mm GTEK™ Sound	-/-/-	GTEK-S010	33
1 x 13mm GTEK™ Fire	1 x 13mm GTEK™ Fire	-/60/60	GTEK-S011	33
1 x 13mm GTEK™ Fire 1 x 10mm GTEK™ Wall	1 x 13mm GTEK™ Fire	-/60/60	GTEK-S012	34
1 x 13mm GTEK™ Fire	2 x 13mm GTEK™ Fire	-/60/60	GTEK-S018	34
1 x 16mm GTEK™ Fire	1 x 16mm GTEK™ Fire	-/60/60	GTEK-S019	34
2 x 13mm GTEK™ Fire	2 x 13mm GTEK™ Fire	-/120/120	GTEK-S021	35
2 x 16mm GTEK™ Fire	2 x 16mm GTEK™ Fire	-/120/120	GTEK-S023	35
3 x 13mm GTEK™ Fire	3 x 13mm GTEK™ Fire	-/120/120	GTEK-S025	35
3 x 16mm GTEK™ Fire	3 x 16mm GTEK™ Fire	120/120/120 -/180/180	GTEK-S026	36
1 x 6mm BGC Duraliner Plus	1 x 6mm BGC Duraliner™ Plus	-/-/-	GTEK-S027	36
1 x 9mm BGC Duraliner Plus	1 x 9mm BGC Duraliner™ Plus	-/-/-	GTEK-S028	36
1 x 12mm BGC Duraliner Plus	1 x 12mm BGC Duraliner™ Plus	-/-/-	GTEK-S029	37
1 x 10mm GTEK™ Sound	1 x 6mm BGC Duraliner™ Plus	-/-/-	GTEK-S031	37
1 x 13mm GTEK™ Wall	1 x 6mm BGC Duraliner™ Plus	-/-/-	GTEK-S033	37
1 x 13mm GTEK™ Wall	1 x 9mm BGC Duraliner™ Plus	-/-/-	GTEK-S034	38
1 x 13mm GTEK™ Fire	1 x 6mm BGC Duraliner™ Plus	-/-/-	GTEK-S035	38
1 x 16mm GTEK™ Fire (against studs) 1 x 9mm BGC Duraliner™ Plus	1 x 16mm GTEK™ Fire (against studs) 1 x 9mm BGC Duraliner™ Plus	60/60/60 -/120/120	GTEK-S041	38
1 x 13mm GTEK™ Fire (against studs) 1 x 6mm Duraliner™ Plus	1 x 13mm GTEK™ Fire (against studs) 1 x 6mm Duraliner™ Plus	-/90/90	GTEK-S042	39
1 x 9mm BGC Duraliner™ Plus (against studs) 1 x 16mm GTEK™ Fire	1 x 9mm BGC Duraliner™ Plus (against studs) 1 x 16mm GTEK™ Fire	-/120/120	GTEK-S043	39
2 x 16mm GTEK™ Fire & Wet Area	2 x 16mm GTEK™ Fire & Wet Area	120/120/120 -/180/180	GTEK-S044	39
1 x 13mm GTEK™ Total Plus	1 x 13mm GTEK™ Total Plus	-/60/60	GTEK-E5S001	40
1 x 13mm GTEK™ Total Plus	2 x 13mm GTEK™ Total Plus	-/60/60	GTEK-E5S002	40
2 x 13mm GTEK™ Total Plus	2 x 13mm GTEK™ Total Plus	90/90/90 -/120/120	GTEK-E5S003	40
-----	3 x 16mm GTEK™ Fire & Wet Area	-/120/120 120/120/120	GTEK-S045	41
-----	2 x 16mm GTEK™ Fire	-/60/60	GTEK-S046	41
-----	3 x 16mm GTEK™ Fire	-/120/120 120/120/120	GTEK-S048	41
-----	3 x 13mm GTEK™ Fire	90/90/90	GTEK-S049	42

QUICK REFERENCE GUIDE

STEEL FRAME – STAGGERED STUD

SIDE 1	SIDE 2	FRL	SYSTEM NUMBER	PAGE NO.
1 x 10mm GTEK™ Wall	1 x 10mm GTEK™ Wall	-/-/-	GTEK-SS001	43
1 x 13mm GTEK™ Wall	1 x 13mm GTEK™ Wall	-/-/-	GTEK-SS002	43
1 x 10mm GTEK™ Sound	1 x 10mm GTEK™ Sound	-/-/-	GTEK-SS006	43
1 x 13mm GTEK™ Sound	1 x 13mm GTEK™ Sound	-/-/-	GTEK-SS007	44
2 x 10mm GTEK™ Sound	2 x 10mm GTEK™ Sound	-/-/-	GTEK-SS010	44
1 x 13mm GTEK™ Fire	1 x 13mm GTEK™ Fire	-/60/60	GTEK-SS011	44
1 x 13mm GTEK™ Fire 1 x 13mm GTEK™ Wall	1 x 13mm GTEK™ Fire	-/60/60	GTEK-SS014	45
2 x 13mm GTEK™ Fire	1 x 13mm GTEK™ Fire	-/60/60	GTEK-SS018	45
1 x 16mm GTEK™ Fire	1 x 16mm GTEK™ Fire	60/60/60 -/60/60	GTEK-SS019	45
1 x 16mm GTEK™ Fire 1 x 13mm GTEK™ Fire	1 x 16mm GTEK™ Fire	60/60/60 -/60/60	GTEK-SS020	46
2 x 13mm GTEK™ Fire	2 x 13mm GTEK™ Fire	90/90/90 -/120/120	GTEK-SS021	46
2 x 16mm GTEK™ Fire	2 x 16mm GTEK™ Fire	120/120/120 -/120/120	GTEK-SS023	46
3 x 16mm GTEK™ Fire	3 x 16mm GTEK™ Fire	120/120/120 -/180/180	GTEK-SS026	47
1 x 9mm BGC Duraliner™ Plus	1 x 9mm BGC Duraliner™ Plus	-/-/-	GTEK-SS028	47
2 x 10mm GTEK™ Sound	1 x 6mm BGC Duraliner™ Plus	-/-/-	GTEK-SS032	47
1 x 13mm GTEK™ Wall	1 x 6mm BGC Duraliner™ Plus	-/-/-	GTEK-SS033	48
1 x 13mm GTEK™ Wall	1 x 9mm BGC Duraliner™ Plus	-/-/-	GTEK-SS034	48
1 x 13mm GTEK™ Fire	1 x 6mm BGC Duraliner™ Plus	-/-/-	GTEK-SS035	48
1 x 9mm BGC Duraliner™ Plus	1 x 16mm GTEK™ Fire	-/-/-	GTEK-SS036	49
1 x 16mm GTEK™ Fire (against studs) 1 x 9mm BGC Duraliner™ Plus	1 x 16mm GTEK™ Fire (against studs) 1 x 9mm BGC Duraliner™ Plus	60/60/60 -/60/60	GTEK-SS041	49
1 x 13mm GTEK™ Fire (against studs) 1 x 6mm BGC Duraliner™ Plus	1 x 13mm GTEK™ Fire (against studs) 1 x 6mm BGC Duraliner™ Plus	-/60/60	GTEK-SS042	49
1 x 9mm BGC Duraliner™ Plus (against studs) 1 x 16mm GTEK™ Fire	1 x 9mm BGC Duraliner™ Plus (against studs) 1 x 16mm GTEK™ Fire	-/120/120 120/120/120	GTEK-SS043	50



QUICK REFERENCE GUIDE

STEEL FRAME – DOUBLE STUD

SIDE 1	SIDE 2	FRL	SYSTEM NUMBER	PAGE NO.
1 x 10mm GTEK™ Wall	1 x 10mm GTEK™ Wall	-/-/-	GTEK-SD001	51
1 x 13mm GTEK™ Wall	1 x 13mm GTEK™ Wall	-/-/-	GTEK-SD002	51
1 x 10mm GTEK™ Sound	1 x 10mm GTEK™ Sound	-/-/-	GTEK-SD006	51
1 x 13mm GTEK™ Sound	1 x 13mm GTEK™ Sound	-/-/-	GTEK-SD007	52
1 x 13mm GTEK™ Fire	1 x 13mm GTEK™ Fire	-/60/60	GTEK-SD011	52
1 x 16mm GTEK™ Fire (against studs) 1 x 10mm GTEK™ Wall	1 x 16mm GTEK™ Fire (against studs) 1 x 10mm GTEK™ Wall	60/60/60 -/60/60	GTEK-SD016	52
1 x 16mm GTEK™ Fire	1 x 16mm GTEK™ Fire	-/60/60 60/60/60	GTEK-SD019	53
2 x 13mm GTEK™ Fire	2 x 13mm GTEK™ Fire	90/90/90 -/120/120	GTEK-SD021	53
2 x 16mm GTEK™ Fire	2 x 16mm GTEK™ Fire	120/120/120 -/120/120	GTEK-SD023	53
2 x 13mm GTEK™ Fire	1 x 13mm GTEK™ Fire	-/60/60	GTEK-SD024	54
3 x 13mm GTEK™ Fire	3 x 13mm GTEK™ Fire	90/90/90 -/120/120	GTEK-SD025	54
3 x 16mm GTEK™ Fire	3 x 16mm GTEK™ Fire	120/120/120 -/180/180	GTEK-SD026	54
1 x 6mm BGC Duraliner™ Plus	1 x 6mm BGC Duraliner™ Plus	-/-/-	GTEK-SD027	55
1 x 9mm BGC Duraliner™ Plus	1 x 9mm BGC Duraliner™ Plus	-/-/-	GTEK-SD028	55
1 x 13mm GTEK™ Fire (against studs) 1 x 6mm BGC Duraliner™ Plus	1 x 13mm GTEK™ Fire (against studs) 1 x 6mm BGC Duraliner™ Plus	-/60/60	GTEK-SD038	55
1 x 6mm BGC Duraliner™ Plus (against studs) 1 x 16mm GTEK™ Fire	1 x 6mm BGC Duraliner™ Plus (against studs) 1 x 16mm GTEK™ Fire	-/60/60 60/60/60	GTEK-SD042	56
1 x 9mm BGC Duraliner™ Plus (against studs) 1 x 16mm GTEK™ Fire	1 x 9mm BGC Duraliner™ Plus (against studs) 1 x 16mm GTEK™ Fire	-/120/120	GTEK-SD043	56
2 x 13mm GTEK™ Total Plus	2 x 13mm GTEK™ Total Plus	-/120/120 90/90/90	GTEK-E5SD001	57

STEEL FRAME – CINEMA WALL

SIDE 1	SIDE 2	FRL	SYSTEM NUMBER	PAGE NO.
3 x 16mm GTEK™ Fire	3 x 16mm GTEK™ Fire	90/90/90	GTEK-SC001	58
4 x 16mm GTEK™ Fire	4 x 16mm GTEK™ Fire	120/120/120	GTEK-SC002	58

COMMERCIAL EXTERIOR WALL

SIDE 1	SIDE 2	FRL	SYSTEM NUMBER	PAGE NO.
	3 x 13mm GTEK™ Fire	90/90/90	GTEK-SCE001	59
	3 x 16mm GTEK™ Fire	90/90/90	GTEK-SCE002	60

QUICK REFERENCE GUIDE

TIMBER FRAME – SINGLE STUD

SIDE 1	SIDE 2	FRL	SYSTEM NUMBER	PAGE NO.
1 x 10mm GTEK™ Wall	1 x 10mm GTEK™ Wall	-/-/-	GTEK-T001	67
1 x 13mm GTEK™ Wall	1 x 13mm GTEK™ Wall	-/-/-	GTEK-T002	67
2 x 10mm GTEK™ Wall	2 x 10mm GTEK™ Wall	-/-/-	GTEK-T004	67
2 x 13mm GTEK™ Wall	2 x 13mm GTEK™ Wall	-/-/-	GTEK-T005	68
1 x 10mm GTEK™ Sound	1 x 10mm GTEK™ Sound	-/-/-	GTEK-T006	68
1 x 13mm GTEK™ Sound	1 x 13mm GTEK™ Sound	-/-/-	GTEK-T007	68
1 x 10mm GTEK™ Sound	1 x 10mm GTEK™ Wet Area	-/-/-	GTEK-T008	69
2 x 10mm GTEK™ Sound	2 x 10mm GTEK™ Sound	-/-/-	GTEK-T010	69
1 x 13mm GTEK™ Fire	1 x 13mm GTEK™ Fire	-/60/60	GTEK-T011	69
1 x 13mm GTEK™ Wall	1 x 10mm GTEK™ Wall 1 x 13mm GTEK™ Fire	-/-/-	GTEK-T015	70
1 x 16mm GTEK™ Fire	1 x 16mm GTEK™ Fire	-/60/60	GTEK-T019	70
2 x 13mm GTEK™ Fire	2 x 13mm GTEK™ Fire	90/90/90	GTEK-T021	70
2 x 16mm GTEK™ Fire	1 x 16mm GTEK™ Fire	-/60/60	GTEK-T022	71
2 x 16mm GTEK™ Fire	2 x 16mm GTEK™ Fire	-/120/120	GTEK-T023	71
3 x 16mm GTEK™ Fire	3 x 16mm GTEK™ Fire	-/180/180	GTEK-T026	71
1 x 6mm BGC Duraliner™ Plus	1 x 6mm BGC Duraliner™ Plus	-/-/-	GTEK-T027	72
1 x 10mm GTEK™ Sound (against studs) 1 x 6mm BGC Duraliner™ Plus	1 x 10mm GTEK™ Sound (against studs) 1 x 6mm BGC Duraliner™ Plus	-/-/-	GTEK-T037	72
1 x 6mm BGC Duraliner™ Plus (against studs) 1 x 13mm GTEK™ Fire	1 x 6mm BGC Duraliner™ Plus (against studs) 1 x 13mm GTEK™ Fire	-/90/90 60/60/60	GTEK-T039	72
1 x 6mm BGC Duraliner™ Plus (against studs) 1 x 16mm GTEK™ Fire	1 x 6mm BGC Duraliner™ Plus (against studs) 1 x 16mm GTEK™ Fire	-/120/120 90/90/90	GTEK-T042	73
2 x 16mm GTEK™ Fire & Wet Area	2 x 16mm GTEK™ Fire & Wet Area	-/180/180	GTEK-T044	73
1 x 13mm GTEK™ Total Plus	1 x 13mm GTEK™ Total Plus	-/60/60 60/60/60	GTEK-E5T001	73
-----	2 x 16mm GTEK™ Fire	-/60/60	GTEK-T046	74
-----	3 x 16mm GTEK™ Fire	-/90/90	GTEK-T048	74

TIMBER FRAME – STAGGERED STUD

SIDE 1	SIDE 2	FRL	SYSTEM NUMBER	PAGE NO.
1 x 10mm GTEK™ Sound	1 x 10mm GTEK™ Sound	-/-/-	GTEK-TS006	75
2 x 10mm GTEK™ Sound	2 x 10mm GTEK™ Sound	-/-/-	GTEK-TS010	75
1 x 13mm GTEK™ Fire	1 x 13mm GTEK™ Fire	-/60/60	GTEK-TS011	75
1 x 16mm GTEK™ Fire	1 x 16mm GTEK™ Fire	-/90/90	GTEK-TS019	76
2 x 13mm GTEK™ Fire	2 x 13mm GTEK™ Fire	-/120/120	GTEK-TS021	76
2 x 16mm GTEK™ Fire	2 x 16mm GTEK™ Fire	-/120/120	GTEK-TS023	76
1 x 6mm BGC Duraliner™ Plus	1 x 6mm BGC Duraliner™ Plus	-/-/-	GTEK-TS027	77
1 x 9mm BGC Duraliner™ Plus	1 x 9mm BGC Duraliner™ Plus	-/-/-	GTEK-TS028	77
1 x 6mm BGC Duraliner™ Plus	1 x 10mm GTEK™ Wall	-/-/-	GTEK-TS030	77
1 x 6mm BGC Duraliner™ Plus	1 x 10mm GTEK™ Sound	-/-/-	GTEK-TS031	78
1 x 6mm BGC Duraliner™ Plus (against studs) 1 x 13mm GTEK™ Fire	1 x 6mm BGC Duraliner™ Plus (against studs) 1 x 13mm GTEK™ Fire	60/60/60	GTEK-TS039	78
1 x 16mm GTEK™ Fire (against studs) 1 x 6mm BGC Duraliner™ Plus	1 x 16mm GTEK™ Fire (against studs) 1 x 6mm BGC Duraliner™ Plus	60/60/60	GTEK-TS040	78
1 x 6mm BGC Duraliner™ Plus (against studs) 1 x 16mm GTEK™ Fire	1 x 6mm BGC Duraliner™ Plus (against studs) 1 x 16mm GTEK™ Fire	90/90/90	GTEK-TS042	79

QUICK REFERENCE GUIDE

TIMBER FRAME – DOUBLE STUD

SIDE 1	SIDE 2	FRL	SYSTEM NUMBER	PAGE NO.
1 x 13mm GTEK™ Fire	1 x 13mm GTEK™ Fire	-/60/60	GTEK-TD011	80
1 x 13mm GTEK™ Wall (against studs) 1 x 13mm GTEK™ Fire	1 x 13mm GTEK™ Wall (against studs) 1 x 13mm GTEK™ Fire	-/60/60	GTEK-TD013	80
1 x 10mm GTEK™ Wall (against studs) 1 x 16mm GTEK™ Fire	1 x 10mm GTEK™ Wall (against studs) 1 x 16mm GTEK™ Fire	-/60/60	GTEK-TD017	80
1 x 16mm GTEK™ Fire	1 x 16mm GTEK™ Fire	-/60/60 60/60/60	GTEK-TD019	81
2 x 13mm GTEK™ Fire	2 x 13mm GTEK™ Fire	90/90/90 -/120/120	GTEK-TD021	81
2 x 16mm GTEK™ Fire	2 x 16mm GTEK™ Fire	-/120/120	GTEK-TD023	81
3 x 16mm GTEK™ Fire	3 x 16mm GTEK™ Fire	-/120/120	GTEK-TD026	82
1 x 6mm BGC Duraliner™ Plus	1 x 6mm BGC Duraliner™ Plus	-/-/-	GTEK-TD027	82
1 x 9mm BGC Duraliner™ Plus	1 x 9mm BGC Duraliner™ Plus	-/-/-	GTEK-TD028	82
1 x 6mm BGC Duraliner™ Plus (against studs) 1 x 13mm GTEK™ Fire	1 x 6mm BGC Duraliner™ Plus (against studs) 1 x 13mm GTEK™ Fire	60/60/60	GTEK-TD039	83
1 x 16mm GTEK™ Fire (against studs) 1 x 6mm BGC Duraliner™ Plus	1 x 16mm GTEK™ Fire (against studs) 1 x 6mm BGC Duraliner™ Plus	60/60/60	GTEK-TD040	83
1 x 6mm BGC Duraliner™ Plus (against studs) 1 x 16mm GTEK™ Fire	1 x 6mm BGC Duraliner™ Plus (against studs) 1 x 16mm GTEK™ Fire	90/90/90	GTEK-TD042	83

## EXTERIOR WALL – TIMBER STUD

SIDE 1	SIDE 2	FRL	SYSTEM NUMBER	PAGE NO.
1 x 16mm GTEK™ Fire & Wet Area 1 x 7.5mm Duratex™	1 x 10mm GTEK™ Wall	60/60/60	GTEK-TE001	87
2 x 16mm GTEK™ Fire & Wet Area 1 x 7.5mm Duratex™	1 x 10mm GTEK™ Wall	90/90/90	GTEK-TE002	87
1 x 16mm GTEK™ Fire & Wet Area 1 x 9mm Duragrid™	1 x 10mm GTEK™ Wall	60/60/60	GTEK-TE003	87
2 x 16mm GTEK™ Fire & Wet Area 1 x 9mm Duragrid™	1 x 10mm GTEK™ Wall	90/90/90	GTEK-TE004	88
1 x 16mm GTEK™ Fire & Wet Area 1 x 9mm Duracom™	1 x 10mm GTEK™ Wall	60/60/60	GTEK-TE005	88
2 x 16mm GTEK™ Fire & Wet Area 1 x 9mm Duracom™	1 x 10mm GTEK™ Wall	90/90/90	GTEK-TE006	88
1 x 16mm GTEK™ Fire & Wet Area 1 x 14mm Nuline™ Plus	1 x 10mm GTEK™ Wall	60/60/60	GTEK-TE007	89
2 x 16mm GTEK™ Fire & Wet Area 1 x 14mm Nuline™ Plus	1 x 10mm GTEK™ Wall	90/90/90	GTEK-TE008	89
1 x 16mm GTEK™ Fire & Wet Area 1 x 9mm Durascape™	1 x 10mm GTEK™ Wall	60/60/60	GTEK-TE009	89
2 x 16mm GTEK™ Fire & Wet Area 1 x 9mm Durascape™	1 x 10mm GTEK™ Wall	90/90/90	GTEK-TE010	90
1 x 16mm GTEK™ Fire & Wet Area 1 x 9mm Duragroove™	1 x 10mm GTEK™ Wall	60/60/60	GTEK-TE011	90
2 x 16mm GTEK™ Fire & Wet Area 1 x 9mm Duragroove™	1 x 10mm GTEK™ Wall	90/90/90	GTEK-TE012	90
1 x 16mm GTEK™ Fire & Wet Area 1 x 12mm Stratum™/Stratum™ Duo/ Stratum™ Trio	1 x 10mm GTEK™ Wall	60/60/60	GTEK-TE013	91
2 x 16mm GTEK™ Fire & Wet Area 1 x 12mm Stratum™/Stratum™ Duo/ Stratum™ Trio	1 x 10mm GTEK™ Wall	90/90/90	GTEK-TE014	91
1 x 16mm GTEK™ Fire & Wet Area 1 x 10mm Stratum™ Contour	1 x 10mm GTEK™ Wall	60/60/60	GTEK-TE015	91
2 x 16mm GTEK™ Fire & Wet Area 1 x 10mm Stratum™ Contour	1 x 10mm GTEK™ Wall	90/90/90	GTEK-TE016	92
1 x 16mm GTEK™ Fire & Wet Area 1 x 10mm Stratum™ Era	1 x 10mm GTEK™ Wall	60/60/60	GTEK-TE017	92
2 x 16mm GTEK™ Fire & Wet Area 1 x 10mm Stratum™ Era	1 x 10mm GTEK™ Wall	90/90/90	GTEK-TE018	92

EXTERIOR WALL – STEEL STUD

SIDE 1	SIDE 2	FRL	SYSTEM NUMBER	PAGE NO.
1 x 16mm GTEK™ Fire & Wet Area 1 x 7.5mm Duratex™	1 x 16mm GTEK™ Fire	60/60/60	GTEK-SE001	93
2 x 16mm GTEK™ Fire & Wet Area 1 x 7.5mm Duratex™	2 x 16mm GTEK™ Fire	90/90/90	GTEK-SE002	93
1 x 16mm GTEK™ Fire & Wet Area 1 x 9mm Duragrid™	1 x 16mm GTEK™ Fire	60/60/60	GTEK-SE003	93
2 x 16mm GTEK™ Fire & Wet Area 1 x 9mm Duragrid™	2 x 16mm GTEK™ Fire	90/90/90	GTEK-SE004	94
1 x 16mm GTEK™ Fire & Wet Area 1 x 9mm Duracom™	1 x 16mm GTEK™ Fire	60/60/60	GTEK-SE005	94
2 x 16mm GTEK™ Fire & Wet Area 1 x 9mm Duracom™	2 x 16mm GTEK™ Fire	90/90/90	GTEK-SE006	94
1 x 16mm GTEK™ Fire & Wet Area 1 x 14mm Nuline™ Plus	1 x 16mm GTEK™ Fire	60/60/60	GTEK-SE007	95
2 x 16mm GTEK™ Fire & Wet Area 1 x 14mm Nuline™ Plus	2 x 16mm GTEK™ Fire	90/90/90	GTEK-SE008	95
1 x 16mm GTEK™ Fire & Wet Area 1 x 9mm Durascape™	1 x 16mm GTEK™ Fire	60/60/60	GTEK-SE009	95
2 x 16mm GTEK™ Fire & Wet Area 1 x 9mm Durascape™	2 x 16mm GTEK™ Fire	90/90/90	GTEK-SE010	96
1 x 16mm GTEK™ Fire & Wet Area 1 x 9mm Duragroove™	1 x 16mm GTEK™ Fire	60/60/60	GTEK-SE011	96
2 x 16mm GTEK™ Fire & Wet Area 1 x 9mm Duragroove™	2 x 16mm GTEK™ Fire	90/90/90	GTEK-SE012	96
1 x 16mm GTEK™ Fire & Wet Area 1 x 12mm Stratum™/Stratum™ Duo/ Stratum™ Trio	1 x 16mm GTEK™ Fire	60/60/60	GTEK-SE013	97
2 x 16mm GTEK™ Fire & Wet Area 1 x 12mm Stratum™/Stratum™ Duo/ Stratum™ Trio	2 x 16mm GTEK™ Fire	90/90/90	GTEK-SE014	97
1 x 16mm GTEK™ Fire & Wet Area 1 x 10mm Stratum™ Contour	1 x 16mm GTEK™ Fire	60/60/60	GTEK-SE015	97
2 x 16mm GTEK™ Fire & Wet Area 1 x 10mm Stratum™ Contour	2 x 16mm GTEK™ Fire	90/90/90	GTEK-SE016	98
1 x 16mm GTEK™ Fire & Wet Area 1 x 10mm Stratum™ Era	1 x 16mm GTEK™ Fire	60/60/60	GTEK-SE017	98
2 x 16mm GTEK™ Fire & Wet Area 1 x 10mm Stratum™ Era	2 x 16mm GTEK™ Fire	90/90/90	GTEK-SE018	98

## FLOOR/CEILING – TIMBER OR STEEL JOISTS

CEILING LINING	FRL	SYSTEM NUMBER	PAGE NO.
1 x 13mm GTEK™ Wall	-/-/	GTEK-C001	101
2 x 13mm GTEK™ Wall	-/-/	GTEK-C002	101
1 x 10mm GTEK™ Ceiling	-/-/	GTEK-C003	101
2 x 10mm GTEK™ Sound	-/-/	GTEK-C004	102
1 x 13mm GTEK™ Fire (against frame) 1 x 16mm GTEK™ Fire	90/90/90	GTEK-C005	102
1 x 16mm GTEK™ Fire	30/30/30	GTEK-C018	102
2 x 16mm GTEK™ Fire	90/90/90	GTEK-C006	103
3 x 16mm GTEK™ Fire	120/120/120	GTEK-C007	103

## FLOOR/CEILING – TIMBER OR STEEL JOISTS WITH FURRING CHANNELS

CEILING LINING	FRL	SYSTEM NUMBER	PAGE NO.
1 x 10mm GTEK™ Ceiling	-/-/	GTEK-C010	104
1 x 13mm GTEK™ Wall	-/-/	GTEK-C011	104
1 x 6mm BGC Duraliner™ Plus (furring channel at 450 max centres)	-/-/	GTEK-C012	104
1 x 9mm BGC Duraliner™ Plus	-/-/	GTEK-C013	105
2 x 13mm GTEK™ Fire	60/60/60	GTEK-C014	105
1 x 13mm GTEK™ Fire (against frame) 1 x 16mm GTEK™ Fire	90/90/90	GTEK-C015	105
2 x 16mm GTEK™ Fire	90/90/90	GTEK-C016	106
3 x 16mm GTEK™ Fire	120/120/120	GTEK-C017	106

## FLOOR/CEILING – TIMBER OR STEEL JOISTS WITH FURRING CHANNELS &amp; RESILIENT MOUNTS

CEILING LINING	FRL	SYSTEM NUMBER	PAGE NO.
1 x 13mm GTEK™ Wall	-/-/	GTEK-C020	107
1 x 10mm GTEK™ Sound	-/-/	GTEK-C021	107
2 x 10mm GTEK™ Sound	-/-/	GTEK-C022	107
1 x 13mm GTEK™ Fire (against frame) 1 x 16mm GTEK™ Fire	90/90/90	GTEK-C023	108
2 x 13mm GTEK™ Fire	60/60/60	GTEK-C024	108
2 x 16mm GTEK™ Fire	90/90/90	GTEK-C025	108

## ROOF/CEILING – TIMBER TRUSSES

CEILING LINING	FRL	SYSTEM NUMBER	PAGE NO.
1 x 10mm GTEK™ Sound	-/-/	GTEK-C030	109
2 x 10mm GTEK™ Sound	-/-/	GTEK-C031	109
1 x 13mm GTEK™ Wall	-/-/	GTEK-C032	109
1 x 13mm GTEK™ Sound	-/-/	GTEK-C033	110
2 x 13mm GTEK™ Fire	60/60/60	GTEK-C037	110
1 x 13mm GTEK™ Fire (against frame) 1 x 16mm GTEK™ Fire	90/90/90	GTEK-C034	110
2 x 16mm GTEK™ Fire	90/90/90	GTEK-C035	111
3 x 16mm GTEK™ Fire	120/120/120	GTEK-C036	111

ROOF/CEILING – TIMBER TRUSSES WITH FURRING CHANNELS

CEILING LINING	FRL	SYSTEM NUMBER	PAGE NO.
1 x 10mm GTEK™ Wall	-/-/	GTEK-C040	112
1 x 10mm GTEK™ Sound	-/-/	GTEK-C041	112
1 x 13mm GTEK™ Sound	-/-/	GTEK-C042	112
1 x 6mm BGC Duraliner™ Plus(furring channels at 450mm max centres)	-/-/	GTEK-C043	113
1 x 13mm GTEK™ Fire (against frame) 1 x 16mm GTEK™ Fire	90/90/90	GTEK-C044	113
2 x 16mm GTEK™ Fire	90/90/90	GTEK-C045	113
3 x 16mm GTEK™ Fire	120/120/120	GTEK-C046	114

ROOF/CEILING – TIMBER TRUSSES WITH FURRING CHANNELS & RESILIAN T MOUNTS

CEILING LINING	FRL	SYSTEM NUMBER	PAGE NO.
1 x 10mm GTEK™ Sound	-/-/	GTEK-C050	115
2 x 10mm GTEK™ Sound	-/-/	GTEK-C051	115
1 x 13mm GTEK™ Fire (against frame) 1 x 16mm GTEK™ Fire	90/90/90	GTEK-C052	115
2 x 16mm GTEK™ Fire	90/90/90	GTEK-C053	116
3 x 16mm GTEK™ Fire	120/120/120	GTEK-C054	116

FLOOR/CEILING – TIMBER OR STEEL JOISTS

CEILING LINING	FRL	SYSTEM NUMBER	PAGE NO.
1 x 13mm GTEK™ Fire	30/-/	GTEK-CB01	119
2 x 13mm GTEK™ Fire	60/-/	GTEK-CB02	119
2 x 16mm GTEK™ Fire	90/-/	GTEK-CB03	119
3 x 13mm GTEK™ Fire	90/-/	GTEK-CB04	119
3 x 16mm GTEK™ Fire	120/-/	GTEK-CB05	119
4 x 16mm GTEK™ Fire	180/-/	GTEK-CB06	119
1 x 13mm GTEK™ Fire	30/-/	GTEK-CB07	120
2 x 13mm GTEK™ Fire	60/-/	GTEK-CB08	120
2 x 16mm GTEK™ Fire	90/-/	GTEK-CB09	120
3 x 16mm GTEK™ Fire	120/-/	GTEK-CB10	120
4 x 16mm GTEK™ Fire	180/-/	GTEK-CB11	120
3 x 13mm GTEK™ Fire	120/-/	GTEK-CB12	120

## STRUCTURE OF WALLS &amp; CEILINGS

## STRUCTURE

## STEEL FRAME DESIGN

AS 1170, Structural design actions – General principles defines the loads that steel framed walls are subjected to. Steel framed wall and ceiling systems must be designed according to the relevant standard:

- ▶ AS 4100, Steel Structures
- ▶ AS/NZS 4600, Cold Formed Steel Structures
- ▶ AS 3623, Domestic Metal Framing
- ▶ AS/NZS 2785, Suspended Ceilings.

## INTERIOR WALLS AND CEILINGS

All interior wall systems and wall height tables published in this Guide comply with the relevant section of BCA Specification C1.8.

- ▶ Height tables for non-fire rated walls have been calculated by Rondo Building Services.

As a minimum, all interior wall systems published in this Guide comply with the deflection under Uniformly Distributed Load (UDL) requirements from BCA Specification C1.8. That is, the allowable deflection under a static pressure of 0.25kPa must be less than either:

- ▶ Wall height ÷ 240, or
- ▶ 30mm.

Some applications have additional requirements such as the walls of shafts and fire isolated exits. Unusually strong wind loading conditions such as those experienced in tall buildings may require interior walls and ceilings to be designed to higher pressures than the standard 0.25kPa. (Refer to BCA)

- ▶ Ensure fasteners used to fix top and bottom track are appropriate for the Uniform Distributed Loads (UDL) on walls.
- ▶ At 600mm fastener centres and a UDL of 0.25kPa, the fasteners must withstand a shear load of 0.75kN.
- ▶ At 600mm fastener centres and a UDL of 0.35kPa, the fasteners must withstand a shear load of 1.1kN.

## EXTERIOR WALLS AND CEILINGS

Frame design of exterior wall systems must consider:

- ▶ Local environmental loading conditions (Refer to AS 1170, Structural Design Actions – General Principles)
- ▶ Applied vertical load on the studs.

## CONTROL JOINTS

Control joints allow for any building movement resulting from influences such as moisture migration, loading, structural movement and foundation settlement. Cracks in plasterboard and plasterboard joints can be eliminated by using control joints and the correct installation techniques. Control joints must be installed in plasterboard walls and ceilings at:

- ▶ Maximum 12 metre intervals
- ▶ Control joints in the structure
- ▶ Any change in the substrate material.

Distance between control joints may need to be reduced to less than 12 metres due to conditions such as large temperature or humidity variations.



STRUCTURE OF WALLS & CEILINGS

TIMBER STUD HEIGHTS		STUD THICKNESS	STUD SPACING	
STUD DEPTH	TIMBER GRADE		600MM	450MM
MAX WALL HEIGHT (M)				
70mm	F5	35mm	3.1	3.4
		45mm	3.4	3.7
	F8	35mm	3.4	3.8
		45mm	3.7	4.1
	F11	35mm	3.6	3.9
		45mm	3.9	4.3
90mm	F5	35mm	4.0	4.4
		45mm	4.4	4.8
	F8	35mm	4.4	4.9
		45mm	4.8	5.2
	F11	35mm	4.6	5.1
		45mm	4.8	5.4
120mm	F5	35mm	5.4	5.8
		45mm	5.8	5.9
	F8	35mm	5.9	6.0
		45mm	6.0	6.0
	F11	35mm	6.0	6.0
		45mm	6.0	6.0

Noggings in timber stud walls must be spaced at 1350mm max centres and must not protrude past the wall framing surface

SCREW FIXINGS FOR SOFT WOOD TIMBER AND LIGHTWEIGHT STEEL FRAMING			SCREW LENGTH		
FRAMING	GTEK™ FIRE THICKNESS	SCREW TYPE	1ST LAYER	2ND LAYER	3RD LAYER
Soft Wood Timber	13mm	No.6 Type 'W'	32mm	50mm	65mm
	16mm	No.6 Type 'W'	45mm	65mm	75mm
Lightweight Steel up to 0.8mm thick	13mm	No.6 Type 'S' Needle Point	25mm	45mm	50mm
	16mm	No.6 Type 'S' Needle Point	30mm	45mm	65mm
Lightweight Steel from 0.8mm to 1.6mm thick	13mm	No.6 Type 'D' Drill Point	32mm	45mm	65mm
	16mm	No.6 Type 'D' Drill Point	32mm	45mm	65mm

STEEL STUD HEIGHTS – NON LOAD BEARING WALLS

Table 1: 0.25kPa - NON LOAD BEARING WALLS

WALL FRAME AND LINING CONFIGURATION	STUD SIZE	51		64		76			92			150		
	BMT	0.5	0.75	0.5	0.75	1.15	0.55	0.75	1.15	0.55	0.75	1.15	0.75	1.15
	LININGS (MM)	MAXIMUM WALL HEIGHT (mm)												
600mm CENTRES LINED BOTH SIDES	10	2770	2910	3330	3920	4160	3710	4420	4650	4550	4830	5110	*6600	*7230
	13	3200	3320	3720	4210	4420	4140	5010	5220	4950	5500	5750	7030	7530
	16	3380	3520	3910	4340	4510	4300	5250	5420	5190	5710	5930	7220	7650
	(-/180/180)													
600mm CENTRES ONE SIDE	10	2310	2620	2720	3130	3520	3230	3590	4060	3740	4160	4710	5300	*6800
	13	2310	2620	2720	3240	3570	3260	3830	4060	3740	4210	4710	5300	6800
	16	2310	2620	2750	3270	3590	3260	3880	4060	3740	4220	4710	5290	6800
STAGGERED STUDS	10			2230	2740	3300								
BOXED STAGGERED STUDS	10			2710	3360	4160								

Table 2: 0.35kPa - NON LOAD BEARING WALLS

WALL FRAME AND LINING CONFIGURATION	STUD SIZE	51		64		76			92			150		
	BMT	0.5	0.75	0.5	0.75	1.15	0.55	0.75	1.15	0.55	0.75	1.15	0.75	1.15
	LININGS (MM)	MAXIMUM WALL HEIGHT (mm)												
600mm CENTRES LINED BOTH SIDES	10	2420	2550	2930	3480	3700	3260	*3880	*4090	*4030	*4220	*4480	*5840	*6420
	13	2810	2920	3290	3740	3930	3650	4420	4600	4400	4840	5060	*6250	*6780
	16	3000	3120	3450	3830	3990	3790	4610	4770	4610	5010	5200	6410	6910
	(-/180/180)													
600mm CENTRES ONE SIDE	10	2070	2340	2430	2800	3150	2890	3210	3630	3340	3720	*4210	*4790	*6210
	13	2070	2340	2430	2880	3170	2890	3380	3630	3340	3720	4210	4790	*6210
	16	2070	2340	2430	2900	3180	2890	3420	3630	3340	3720	4210	4780	6210
STAGGERED STUDS	10			2020	2470	2960								
BOXED STAGGERED STUDS	10			2490	3040	3710								

Table 3: NOGGING REQUIREMENTS

LINING CONFIGURATION	WALL HEIGHT	NO. OF NOGGINGS
LINED BOTH SIDES	0 - 4400	0
	4400 - 8800	1
LINED ONE SIDE	0 - 3000	1
	3000 - 6000	2
	6000 - 8000	3
STAGGERED STUDS	All	0

Table 4: WALL HEIGHT LIMITS BASED ON WALL LININGS

LINING CONFIGURATION	WALL HEIGHT	MAX WALL HEIGHTS	
		0.25kPa	0.35kPa
LINED BOTH SIDES	1 x 10mm	5330	3800
	1 x 13mm	8000	5710
	1 x 16mm	12000	8570
LINED ONE SIDE	0.50/0.55BMT	5330	3800
	1 x 10mm	5330	3800
	1 x 13mm	8000	5710
	1 x 16mm	10000	7140
STAGGERED STUDS	1 x 10mm	5330	3800

Notes to Tables: Information provided by Rondo Building Services and as such the performances detailed are limited to the Rondo range of products. Deflection limited to the lesser of H/240 or 30mm, in accordance with the BCA Specification C1.8

All walls are non load bearing, except for self weight

Table 1 loadings: Pultimate = 0.375kPa, Pservice = 0.25kPa

Table 2 loadings: Pultimate = 0.525kPa, Pservice = 0.35kPa

All loadings in accordance with AS1170:2002

Walls analysed in accordance with AS/NZS4600 / Noggings are to be installed as per Table 3

Staggered stud walls have been checked based on zero noggings, and assumed 92mm tracks

Tables have been prepared by Rondo Building Services Pty Ltd / The design pressures are not suitable for external wall applications

The wall heights assume the stud and track sections are of the same, or similar, gauge /

Wall heights do not consider connection capacity, which should be checked as per Table 4 / \*Green highlights indicate wall height may be limited by plasterboard linings

At BGC we care about the environment and now have a range of GECA Certified Plasterboard Products available. As part of our commitment to sustainability we are offering our Environmentally Certified GTEK™ range at no extra cost to you. So now you save money whilst together we save the environment.



**BGC Plasterboard shares the general community concern for the environment and seeks to reduce its environmental footprint in all aspects of its operations. That means you can specify GTEK™ to help create you next green star rated home or project.**

We use up to 15% recycled gypsum in our boards and we use 100% recycled paper lining front and back.

BGC Plasterboard has set prudent environmental targets for waste minimisation and energy and water use, and is an active participant in environmental reporting through the Energy Efficiency, Waterwise and Emissions reporting programs.

Through strict quality control systems, production waste is minimised and wastage is recycled back into new plasterboard.

Good Environmental Choice Australia is an environmental labelling program which aims to provide consumers with the knowledge that the product they are purchasing has met certain environmental performance standards which have been developed and assessed in line with International labelling standards.

Scientifically recognised benchmarks for environmental performance have been developed against which products and services are assessed and evaluated to determine whether the product or service should be awarded the Good Environmental Choice Label. GECA certification is recognised by the Green Building Council of Australia and may assist in achieving up to 3 Green Star points.

GTEK™ products have been certified by GECA which means that the products and their manufacturing environment have been evaluated and deemed to comply with the strict guidelines set by GECA

We're proud to wear the Good Environmental Choice label, it shows our products and manufacturing environment complies with GECA's strict guidelines.

Now 'Building it better with BGC' also means building a cleaner and more sustainable environment.



BGC-2014  
GECA 04 2011 v2  
Panel Boards



## EXTERIOR WALLS/BUSHFIRE INFORMATION

**BOUNDARY/EXTERIOR WALLS**

Certain BGC Fibre Cement products when used in conjunction with 16mm GTEK™ Fire & Wet Area can achieve both 60/60/60 and 90/90/90 FRL (Fire Resistance Level) fire ratings from the outside as required by the National Construction Code.

Where an exterior wall is required to achieve 60/60/60 FRL from the outside, 1 layer of 16mm Wet Area Fireboard installed with certain BGC Fibre Cement products over the Wet Area Fireboard will meet minimum National Construction Code requirements.

Similarly 2 layers of 16mm GTEK™ Fire & Wet Area used in conjunction with certain BGC Fibre Cement products will achieve 90/90/90 from the outside.

There are 11 BGC Fibre Cement products that can be used in conjunction with 16mm GTEK™ Fire & Wet Area to achieve the fire ratings required for boundary/exterior walls. These are:

- ▶ 7.5mm Duratex™
- ▶ 9mm Duragrid™
- ▶ 9mm Duracom™
- ▶ 9mm Durascape™
- ▶ 9mm Duragroove™
- ▶ 14mm Nuline™ Plus
- ▶ 12mm Stratum™
- ▶ 12mm Stratum™ Duo
- ▶ 12mm Stratum™ Trio
- ▶ 10mm Stratum™
- ▶ Contour
- ▶ 10mm Stratum™ Era

**NOTE:** All exterior walls must have sarking beneath the BGC Fibre Cement products. No adhesives are to be used when installing GTEK™ Fire & Wet Area and the BGC Fibre Cement products. Nails or screws must be used.

**BUSHFIRE INFORMATION**

AS3959:2009 sets out a series of Bushfire threat levels to buildings described as BAL (Bushfire Attack Levels) as follows:

BAL-Low, BAL-12.5, BAL-19, BAL-29, BAL-40 or BAL-FZ (Flamezone).

BGC Fibre Cement and GTEK™ products are eminently suited for both bushfire and boundary wall applications in residential and multi residential buildings when used correctly.

The chart on the next pages shows the different BAL levels that different BGC Fibre Cement and GTEK™ products can achieve if installed correctly.

For detailed Fire and Acoustic results as well as fixing sketches for different products, please see the Exterior Wall pages in the Fire and Acoustic Data section of this guide on pages 85-98.

BUSHFIRE MATRIX

APPLICATIONS	BAL 12.5	BAL 19	BAL 29	BAL 40	BAL FZ>10m	BAL FZ <10m
Materials to enclose subfloor spaces to buildings	Durasheet™ 4.5mm	Durasheet™ 4.5mm	Durasheet™ 6mm	Duracom™ 9mm		
	Durasheet™ 6mm	Durasheet™ 6mm	Duracom™ 9mm	Duracom™ 12mm		
	Duracom™ 9mm	Duracom™ 9mm	Duracom™ 12mm	Duratex™ 9mm		
	Duracom™ 12mm	Duracom™ 12mm	Duratex™ 7.5mm	Durascape™ 9mm		
	Duratex™ 7.5mm	Duratex™ 7.5mm	Duratex™ 9mm	Duragroove™ Narrow, Wide, Extra Wide and Woodgrain 9mm		
	Duratex™ 9mm	Duratex™ 9mm	Duraplank™ 7.5mm	Nuline™ Plus 14mm		
	Duraplank™ 7.5mm	Duraplank™ 7.5mm	Durascape™ 9mm	Stratum™, Stratum™ Duo and Stratum™ Trio 12mm		
	Durascape™ 9mm	Durascape™ 9mm	Duragroove™ Narrow, Wide, Extra Wide and Woodgrain 9mm	Stratum™ Era 10mm		
	Duragroove™ Narrow, Wide, Extra Wide and Woodgrain 9mm	Duragroove™ Narrow, Wide, Extra Wide and Woodgrain 9mm	Nuline™ Plus 14mm	Stratum™ Contour 10mm		
	Nuline™ Plus 14mm	Nuline™ Plus 14mm	Stratum™, Stratum™ Duo and Stratum™ Trio 12mm			
	Stratum™, Stratum™ Duo and Stratum™ Trio 12mm	Stratum™, Stratum™ Duo and Stratum™ Trio 12mm	Stratum™ Era 10mm			
	Stratum™ Era 10mm	Stratum™ Era 10mm	Stratum™ Contour 10mm			
	Stratum™ Contour 10mm	Stratum™ Contour 10mm				
External walls (parts less than 400mm from ground or near horizontal surface (<18° to horizontal) and >110mm in width from wall)	Durasheet™ 6mm	Durasheet™ 6mm	Durasheet™ 6mm	Duracom™ 9mm	BGC system - T051	
	Duracom™ 9mm	Duracom™ 9mm	Duracom™ 9mm	Duracom™ 12mm	<b>Exposed side</b>	
	Duracom™ 12mm	Duracom™ 12mm	Duracom™ 12mm	Duratex™ 9mm	7.5mm Duratex™ or 9mm Duragrid™ or 9mm/12mm Duracom™ or 9mm Durascape™ or 9mm Duragroove™ or 14mm Nuline™ Plus or 10mm Stratum™ Era or 10mm Stratum™ Contour or 12mm Stratum™, Stratum™ Duo, Stratum™ Trio	
	Duratex™ 7.5mm	Duratex™ 7.5mm	Duratex™ 7.5mm	Durascape™ 9mm	16mm GTEK™ Fire & Wet Area	
	Duratex™ 9mm	Duratex™ 9mm	Duratex™ 9mm	Duragroove™ Narrow, Wide, Extra Wide and Woodgrain 9mm	<b>Unexposed Side</b>	
	Duraplank™ 7.5mm	Duraplank™ 7.5mm	Duraplank™ 7.5mm	Nuline™ Plus 14mm	10mm GTEK™ Wall	
	Durascape™ 9mm	Durascape™ 9mm	Durascape™ 9mm	Stratum™, Stratum™ Duo and Stratum™ Trio 12mm		
	Duragroove™ Narrow, Wide, Extra Wide and Woodgrain 9mm	Duragroove™ Narrow, Wide, Extra Wide and Woodgrain 9mm	Duragroove™ Narrow, Wide, Extra Wide and Woodgrain 9mm	Stratum™ Era 10mm		
	Nuline™ Plus 14mm	Nuline™ Plus 14mm	Nuline™ Plus 14mm	Stratum™ Contour 10mm		
	Stratum™, Stratum™ Duo and Stratum™ Trio 12mm	Stratum™, Stratum™ Duo and Stratum™ Trio 12mm	Stratum™, Stratum™ Duo and Stratum™ Trio 12mm			
	Stratum™ Era 10mm	Stratum™ Era 10mm	Stratum™ Era 10mm			
	Stratum™ Contour 10mm	Stratum™ Contour 10mm	Stratum™ Contour 10mm			
	External walls (other)	Durasheet™ 4.5mm	Durasheet™ 4.5mm	Durasheet™ 6mm	Duracom™ 9mm	BGC system - T051
Durasheet™ 6mm		Durasheet™ 6mm	Duracom™ 9mm	Duracom™ 12mm	<b>Exposed side</b>	
Duracom™ 9mm		Duracom™ 9mm	Duracom™ 12mm	Duratex™ 9mm	7.5mm Duratex™ or 9mm Duragrid™ or 9mm/12mm Duracom™ or 9mm Durascape™ or 9mm Duragroove™ or 14mm Nuline™ Plus	
Duracom™ 12mm		Duracom™ 12mm	Duratex™ 7.5mm	Nuline™ Plus 14mm	16mm GTEK™ Fire & Wet Area	
Duratex™ 7.5mm		Duratex™ 7.5mm	Duratex™ 9mm	Durascape™ 9mm	<b>Unexposed Side</b>	
Duratex™ 9mm		Duratex™ 9mm	Duraplank™ 7.5mm	Duragroove™ Narrow, Wide, Extra Wide and Woodgrain 9mm	10mm GTEK™ Wall	
Duraplank™ 7.5mm		Duraplank™ 7.5mm	Durascape™ 9mm	Stratum™, Stratum™ Duo and Stratum™ Trio 12mm		
Durascape™ 9mm		Durascape™ 9mm	Duragroove™ Narrow, Wide, Extra Wide and Woodgrain 9mm	Stratum™ Era 10mm		
Duragroove™ Narrow, Wide, Extra Wide and Woodgrain 9mm		Duragroove™ Narrow, Wide, Extra Wide and Woodgrain 9mm	Nuline™ Plus 14mm	Stratum™ Contour 10mm		
Nuline™ Plus 14mm		Nuline™ Plus 14mm	Stratum™, Stratum™ Duo and Stratum™ Trio 12mm			
Stratum™, Stratum™ Duo and Stratum™ Trio 12mm		Stratum™, Stratum™ Duo and Stratum™ Trio 12mm	Stratum™ Era 10mm			
Stratum™ Era 10mm		Stratum™ Era 10mm	Stratum™ Contour 10mm			
Stratum™ Contour 10mm		Stratum™ Contour 10mm				

**BUSHFIRE MATRIX**

APPLICATIONS	BAL 12.5	BAL 19	BAL 29	BAL 40	BAL FZ>10m	BAL FZ <10m
Eaves lining	Durasheet™ 4.5mm	Durasheet™ 4.5mm	Durasheet™ 4.5mm	Durasheet™ 6mm		
	Durasheet™ 6mm	Durasheet™ 6mm	Durasheet™ 6mm	Duracom™ 9mm		
	Duracom™ 9mm	Duracom™ 9mm	Duracom™ 9mm	Duracom™ 12mm		
	Duracom™ 12mm	Duracom™ 12mm	Duracom™ 12mm	Duratex™ 7.5mm		
	Duratex™ 7.5mm	Duratex™ 7.5mm	Duratex™ 7.5mm	Duratex™ 9mm		
	Duratex™ 9mm	Duratex™ 9mm	Duratex™ 9mm	Duraplank™ 7.5mm		
	Duraplank™ 7.5mm	Duraplank™ 7.5mm	Duraplank™ 7.5mm	Durascap™ 9mm		
	Durascap™ 9mm	Durascap™ 9mm	Durascap™ 9mm	Duragroove™ Narrow, Wide, Extra Wide and Woodgrain 9mm		
	Duragroove™ Narrow, Wide, Extra Wide and Woodgrain 9mm	Duragroove™ Narrow, Wide, Extra Wide and Woodgrain 9mm	Duragroove™ Narrow, Wide, Extra Wide and Woodgrain 9mm	Nuline™ Plus 14mm		
	Nuline™ Plus 14mm	Nuline™ Plus 14mm	Nuline™ Plus 14mm	Stratum™, Stratum™ Duo and Stratum™ Trio 12mm		
Fascias and bargeboards	Stratum™, Stratum™ Duo and Stratum™ Trio 12mm	Stratum™, Stratum™ Duo and Stratum™ Trio 12mm	Stratum™, Stratum™ Duo and Stratum™ Trio 12mm	Stratum™ Era 10mm		
	Stratum™ Era 10mm	Stratum™ Era 10mm	Stratum™ Era 10mm	Stratum™ Contour 10mm		
	Stratum™ Contour 10mm	Stratum™ Contour 10mm	Stratum™ Contour 10mm	Durasheet™ 4.5mm		
	Durasheet™ 4.5mm	Durasheet™ 4.5mm	Durasheet™ 4.5mm			
	Duracom™ 9mm	Duracom™ 9mm	Duracom™ 9mm			
	Duracom™ 12mm	Duracom™ 12mm	Duracom™ 12mm			
	Duratex™ 7.5mm	Duratex™ 7.5mm	Duratex™ 7.5mm			
	Duratex™ 9mm	Duratex™ 9mm	Duratex™ 9mm			
	Duraplank™ 7.5mm	Duraplank™ 7.5mm	Duraplank™ 7.5mm			
	Durascap™ 9mm	Durascap™ 9mm	Durascap™ 9mm			
Gables (parts less than 400mm from ground or near horizontal surface (<18° to horizontal) and >110mm in width from wall)	Duragroove™ Narrow, Wide, Extra Wide and Woodgrain 9mm	Duragroove™ Narrow, Wide, Extra Wide and Woodgrain 9mm	Duragroove™ Narrow, Wide, Extra Wide and Woodgrain 9mm			
	Nuline™ Plus 14mm	Nuline™ Plus 14mm	Nuline™ Plus 14mm			
	Stratum™, Stratum™ Duo and Stratum™ Trio 12mm	Stratum™, Stratum™ Duo and Stratum™ Trio 12mm	Stratum™, Stratum™ Duo and Stratum™ Trio 12mm			
	Stratum™ Era 10mm	Stratum™ Era 10mm	Stratum™ Era 10mm			
	Stratum™ Contour 10mm	Stratum™ Contour 10mm	Stratum™ Contour 10mm			
	Durasheet™ 6mm	Durasheet™ 6mm	Durasheet™ 6mm	Duracom™ 9mm		
	Duracom™ 9mm	Duracom™ 9mm	Duracom™ 9mm	Duracom™ 12mm		
	Duracom™ 12mm	Duracom™ 12mm	Duracom™ 12mm	Duratex™ 9mm		
	Duratex™ 7.5mm	Duratex™ 7.5mm	Duratex™ 7.5mm	Durascap™ 9mm		
	Duratex™ 9mm	Duratex™ 9mm	Duratex™ 9mm	Duragroove™ Narrow, Wide, Extra Wide and Woodgrain 9mm		
Gables (other)	Duraplank™ 7.5mm	Duraplank™ 7.5mm	Duraplank™ 7.5mm	Nuline™ Plus 14mm		
	Durascap™ 9mm	Durascap™ 9mm	Durascap™ 9mm	Stratum™, Stratum™ Duo and Stratum™ Trio 12mm		
	Duragroove™ Narrow, Wide, Extra Wide and Woodgrain 9mm	Duragroove™ Narrow, Wide, Extra Wide and Woodgrain 9mm	Duragroove™ Narrow, Wide, Extra Wide and Woodgrain 9mm	Stratum™ Era 10mm		
	Nuline™ Plus 14mm	Nuline™ Plus 14mm	Nuline™ Plus 14mm	Stratum™ Contour 10mm		
	Stratum™, Stratum™ Duo and Stratum™ Trio 12mm	Stratum™, Stratum™ Duo and Stratum™ Trio 12mm	Stratum™, Stratum™ Duo and Stratum™ Trio 12mm			
	Stratum™ Era 10mm	Stratum™ Era 10mm	Stratum™ Era 10mm			
	Stratum™ Contour 10mm	Stratum™ Contour 10mm	Stratum™ Contour 10mm			
	Durasheet™ 4.5mm	Durasheet™ 4.5mm	Durasheet™ 6mm	Duracom™ 9mm		
	Durasheet™ 6mm	Durasheet™ 6mm	Duracom™ 9mm	Duracom™ 12mm		
	Duracom™ 9mm	Duracom™ 9mm	Duracom™ 12mm	Duratex™ 9mm		
Materials to enclose subfloor spaces of verandas, decks steps, ramps and landings	Duracom™ 12mm	Duracom™ 12mm	Duratex™ 7.5mm	Durascap™ 9mm		
	Duratex™ 7.5mm	Duratex™ 7.5mm	Duratex™ 9mm	Duragroove™ Narrow, Wide, Extra Wide and Woodgrain 9mm		
	Duratex™ 9mm	Duratex™ 9mm	Duraplank™ 7.5mm	Nuline™ Plus 14mm		
	Duraplank™ 7.5mm	Duraplank™ 7.5mm	Durascap™ 9mm	Stratum™, Stratum™ Duo and Stratum™ Trio 12mm		
	Durascap™ 9mm	Durascap™ 9mm	Duragroove™ Narrow, Wide, Extra Wide and Woodgrain 9mm	Stratum™ Era 10mm		
	Duragroove™ Narrow, Wide, Extra Wide and Woodgrain 9mm	Duragroove™ Narrow, Wide, Extra Wide and Woodgrain 9mm	Nuline™ Plus 14mm	Stratum™ Contour 10mm		
	Nuline™ Plus 14mm	Nuline™ Plus 14mm	Stratum™, Stratum™ Duo and Stratum™ Trio 12mm			
	Stratum™, Stratum™ Duo and Stratum™ Trio 12mm	Stratum™, Stratum™ Duo and Stratum™ Trio 12mm	Stratum™ Era 10mm			
	Stratum™ Era 10mm	Stratum™ Era 10mm	Stratum™ Contour 10mm			
	Stratum™ Contour 10mm	Stratum™ Contour 10mm	Stratum™ Contour 10mm			
Materials to enclose subfloor spaces of verandas, decks steps, ramps and landings	Durasheet™ 4.5mm (over 400mm)	Durasheet™ 4.5mm (over 400mm)	Durasheet™ 4.5mm (over 400mm)	Duracom™ 9mm		
	Durasheet™ 6mm	Durasheet™ 6mm	Durasheet™ 6mm	Duracom™ 12mm		
	Duracom™ 9mm	Duracom™ 9mm	Duracom™ 9mm	Duratex™ 9mm		
	Duracom™ 12mm	Duracom™ 12mm	Duracom™ 12mm	Durascap™ 9mm		
	Duratex™ 7.5mm	Duratex™ 7.5mm	Duratex™ 7.5mm	Duragroove™ 9mm		
	Duratex™ 9mm	Duratex™ 9mm	Duratex™ 9mm	Nuline™ Plus 14mm		
	Duraplank™ 7.5mm	Duraplank™ 7.5mm	Duraplank™ 7.5mm	Stratum™, Stratum™ Duo and Stratum™ Trio 12mm		
	Durascap™ 9mm	Durascap™ 9mm	Durascap™ 9mm	Stratum™ Era 10mm		
	Duragroove™ 9mm	Duragroove™ 9mm	Duragroove™ 9mm	Stratum™ Contour 10mm		
	Nuline™ Plus 14mm	Nuline™ Plus 14mm	Nuline™ Plus 14mm			
Stratum™, Stratum™ Duo and Stratum™ Trio 12mm	Stratum™, Stratum™ Duo and Stratum™ Trio 12mm	Stratum™, Stratum™ Duo and Stratum™ Trio 12mm				
Stratum™ Era 10mm	Stratum™ Era 10mm	Stratum™ Era 10mm				
Stratum™ Contour 10mm	Stratum™ Contour 10mm	Stratum™ Contour 10mm				

ACOUSTICS

**SOUND INSULATION**

Every partition has a sound insulation rating. A very basic partition may have a sound insulation rating of approximately  $R_w30$ . A cinema partition on the other hand may have a rating of around  $R_w70$ .

Sometimes the  $R_w$  value includes a  $C_{tr}$  rating,  $R_w + C_{tr}$ .  $C_{tr}$  is a sound insulation rating for low-frequency noise, like trucks and stereo subwoofers.

For example, the  $R_w45$  partition below has a  $C_{tr}$  rating of -11.

BASIC WALL	CINEMA WALL
<b>GTEK-S001</b>	<b>GTEK-SC001</b>
<b><math>R_w30</math></b>	<b><math>R_w70</math></b>

<b>GTEK-S002</b>
<b><math>R_w45</math></b>
<b><math>C_{tr} -11</math></b>
<b><math>R_w + C_{tr} 34</math></b>

The  $R_w$  value is the sound insulation rating, for airborne sound.

A higher  $R_w$  rating means a better partition for sound insulation. Airborne sound insulation ratings can range from as low as  $R_w 10 -15$  up to values of  $R_w 75$  and greater. Examples of  $R_w$  ratings for different types of partitions are shown below.

Here, the combined sound insulation rating is  $R_w + C_{tr} 34$ .

$C_{tr}$  is a negative number and values typically range from about -4 to about -12. The  $C_{tr}$  rating depends on the mass of the partition. A heavier partition will have a smaller  $C_{tr}$  rating.

Choosing the right partition for the job means choosing a partition with the right sound insulation rating. If acoustics is important for your project, we recommend that you contact a qualified acoustic consultant for advice.

CONSTRUCTION	Typical $R_w$	EG: PARTITIONS SEPARATING:
 <b>GTEK-S001</b>	30	RETAIL TENANCIES
 <b>GTEK-S010</b>	40	PRIVATE OFFICES
 <b>GTEK-SS010</b>	55	BOARD ROOMS

CONSTRUCTION	Typical $R_w$	EG: PARTITIONS SEPARATING:
 <b>GTEK-SD023</b>	65	APARTMENTS
 <b>GTEK-SD025</b>	70	CINEMAS

ACOUSTICS

**BUILDING CODE OF AUSTRALIA:  
WHO, WHAT, WHY AND HOW?**

**Who?**

The National Construction Code (NCC) sets acoustic ratings for residential buildings.

**What?**

The NCC sets acoustic ratings for a range of buildings including apartments, hotels, student accommodation and aged-care buildings. The acoustic ratings are for inter-tenancy walls and floors in these buildings.

For example, a wall between two apartments should have an airborne sound insulation rating of  $R_w + C_{tr}$  50.

Acoustic ratings also apply to entry doors and to services such as ducting and water, soil and waste pipes in the inter-tenancy walls, floors and riser shafts.

**Why?**

The BCA ratings are a minimum acoustic standard for residential buildings. This means that someone living in an apartment can expect a reasonable amount of acoustic privacy from their neighbours.

The NCC ratings are a minimum standard. Apartments and buildings built to a higher quality level generally require walls and floors which exceed NCC standards.

**How?**

Different sound insulation ratings apply to different building elements, depending on the rooms being separated. In some cases ratings include the  $C_{tr}$ . Some cases also include a requirement for the partition to be discontinuous (see below for further discussion).

The specific acoustic requirements from the NCC are detailed in the table below.

**BCA AIRBOURNE SOUND INSULATION CRITERIA SUMMARY FOR APARTMENTS AND TOWNHOUSES (SOLE OCCUPANCY UNITS)**

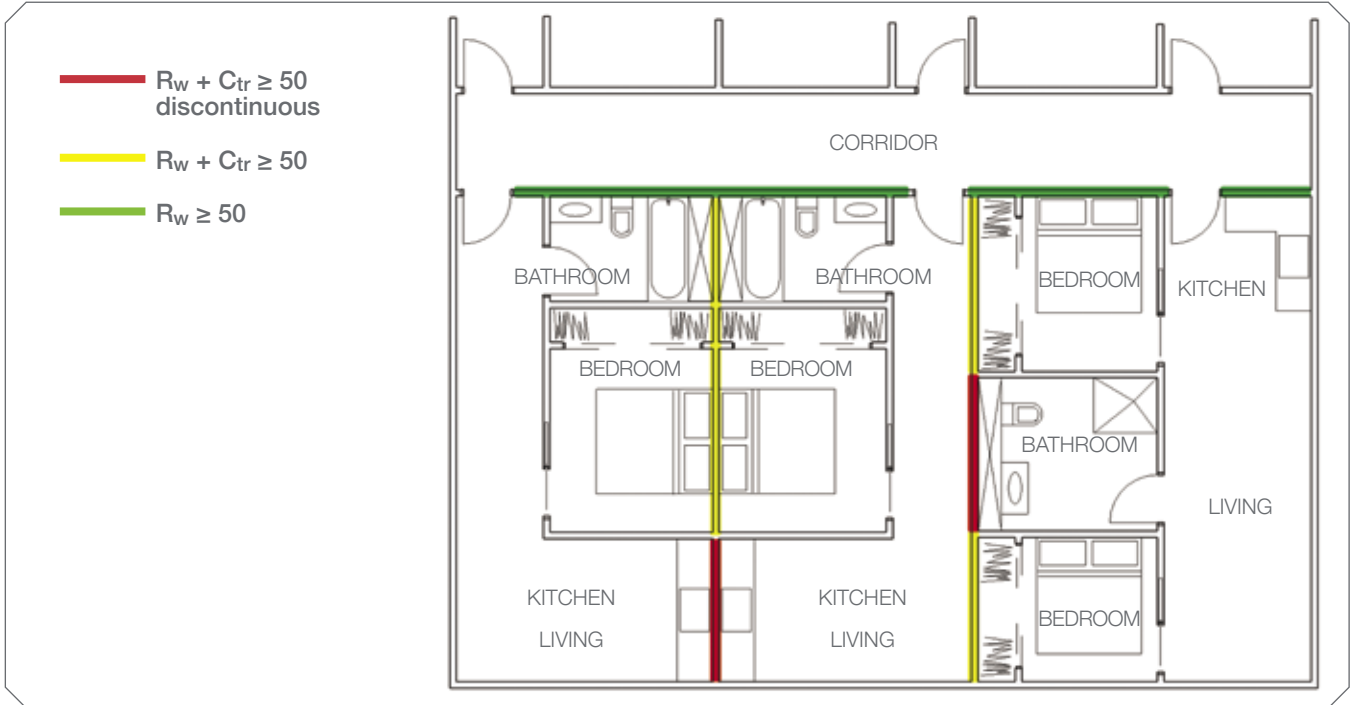
SEPARATED AREAS	Criteria <sup>1,2</sup>	DISCONTINUOUS CONSTRUCTION REQUIRED <sup>2</sup>	NOTES
<b>Walls</b>			
Two habitable rooms	$R_w + C_{TR} \geq 50$	No	Habitable rooms include living areas and bedrooms
Two wet areas	$R_w + C_{TR} \geq 50$	No	Wet areas include bathrooms, laundries and kitchens
A wet area or kitchen and a habitable room	$R_w + C_{TR} \geq 50$	Yes	Generally includes walls separating wet areas and open plan kitchen-lounges
A sole occupancy unit and a common space	$R_w \geq 50$	No	Common spaces include stairways, public corridors and public lobbies. Also applies to areas of a different BCA classification
A sole occupancy unit and a plant room	$R_w \geq 50$	Yes	Also applies to lift shafts
<b>Floors</b>			
Two sole occupancy units	$R_w + C_{TR} \geq 50$	No	Floor impact isolation criteria ( $L_{n,w}$ ) also apply
A sole occupancy unit and a plant room or common space	$R_w + C_{TR} \geq 50$	No	Also applies to lift shafts, stairways, public corridors and public lobbies. Floor impact isolation treatment also required
<b>Doors</b>			
A sole occupancy unit and a common space	$R_w \geq 30$	No	Common spaces include stairways, public corridors and public lobbies.
<b>Services</b>			
A habitable room and a duct, soil, waste or water pipe from a different unit	$R_w + C_{TR} \geq 40$	No	Applies to internal service ducts and pipes and stormwater pipes in wall, floors and risers
A habitable room and a duct, soil, waste or water pipe from a different unit	$R_w + C_{TR} \geq 25$	No	Applies to internal service ducts and pipes and stormwater pipes in wall, floors and risers

1. The National Construction Code criteria in the table apply to Class 2 and Class 3 buildings in all states and territories except the Northern Territory  
 2. Alternative National Construction Code criteria apply to Class 2 and Class 3 buildings in the Northern Territory and to Class 9C (Aged Care) buildings in all states and territories.  
 BGC Recommends seeking expert advice for these alternative criteria



ACOUSTICS

The figure below shows an example of the type of acoustic performance required to inter-tenancy partitions separating two apartments.



Example of BCA performance requirements for different sections of inter-tenancy partitions

The acoustic performance of the wall depends on the type of room on each side of the partition. For example, where the wall separates a bedroom or living area in one apartment from a wet area such as a kitchen or bathroom in another apartment, the

partition should be of discontinuous construction. The acoustic performance of a partition between an apartment and a common corridor does not include the  $C_{tr}$ .

BGC RECOMMENDED WALL TYPE

**APARTMENT INTER-TENANCY WALL**

Where acoustic amenity is required to exceed the National Construction Code. Minimum performance requirement, we recommend wall system GTEK-SD019 for inter-tenancy walls between apartments.



GTEK-SD019

The system has a laboratory test report 15-099/JW RMIT  $R_w + C_{tr}$  51.

This wall system is classified as a discontinuous construction and exceeds the inter-tenancy partition requirements of the National Construction Code. Wall structure is cavity width 148mm, wall thickness 180mm. Cavity packed tightly with 2 lays of 75mm thick 14kg/m<sup>2</sup> glasswool.

## ACOUSTIC CONCEPTS

**INSULATION IN WALL, FLOOR AND ROOF CONSTRUCTIONS**

Acoustic ratings in this Guide are provided for two different types of glasswool insulation: 50mm thick, 9kg/m<sup>3</sup> glasswool and 75mm thick, 30kg/m<sup>3</sup> glasswool. Fibreglass insulation of the same thickness and mass may be used in lieu of these two types of glasswool without compromising the acoustic ratings.

**ON-SITE PERFORMANCE**

In an acoustic laboratory, sound insulation ratings are measured using purpose built rooms which give very accurate, reproducible results. The  $R_w$  value is a laboratory result.

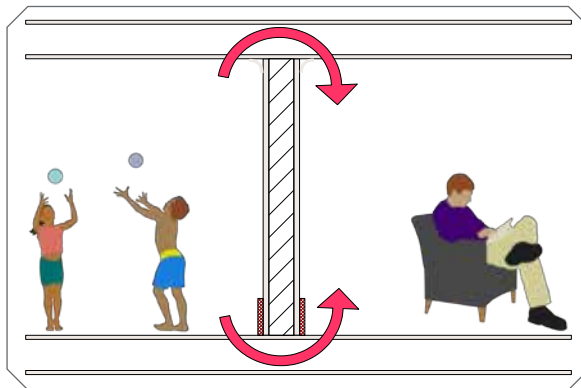
Things are not so simple on site. For example, the rating of a wall can be affected by the floor it is mounted on, the overhead ceiling, the side walls and any penetrations and services which run through the wall or floor above. The  $D_{nT,w}$  value is an on site result.

The  $R_w$  and  $D_{nT,w}$  values are similar in concept but are not the same. The difference is the  $D_{nT,w}$  accounts for the imperfect testing conditions found on site. As a guide, the  $D_{nT,w}$  value of a partition is typically around 5dB lower than the  $R_w$  value.

The  $C_{tr}$  correction can be applied to both  $R_w$  and  $D_{nT,w}$  ratings. For example, the BCA states that walls separating adjacent apartments should have a minimum  $D_{nT,w} + C_{tr}$  45 rating, when site verification is being used for assessment purposes.

**FLANKING**

Flanking transmission means sound transmission around the partition rather than through it.

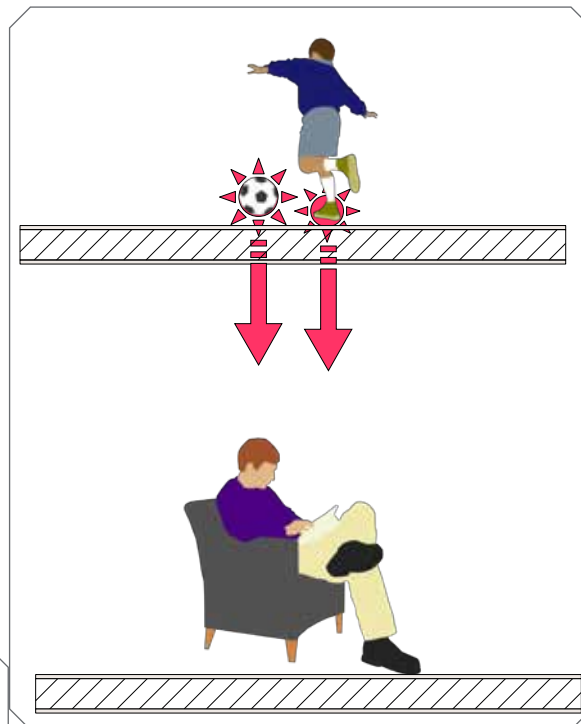


Flanking transmission can occur when the floor, walls or ceiling around a separating partition have poor sound insulation, which decreases the performance of the separating partition. Flanking transmission is common on site and should be carefully assessed.

**IMPACT SOUND AND DISCONTINUITY**

So far, we have covered airborne sound which means sound such as voices and audio-speakers which travels through air. Impact sound means sound generated from impact on the partitions and floors of the building.

For example, if someone walks on their tiled floor, a person on the floor beneath will hear the impact sound. Another example is someone closing a kitchen cupboard. If the cupboard is connected to the wall, a person on the other side of the wall will hear the impact sound from the cupboard door.



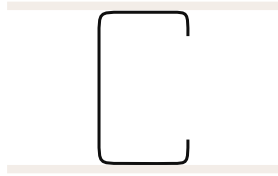
In the BCA some partitions need to provide wall impact isolation. For example, a partition between a kitchen or bathroom in one apartment and a living room or bedroom in another apartment should have a discontinuous construction. This means the partition should include a structural break. For example, double stud partitions are discontinuous and single steel studs partitions are not.

**RESILIENT ACOUSTIC MOUNTS**

Refer to selected floor/ceiling systems in this guide where resilient acoustic mounts may be required. There are a number of resilient acoustic mounts available in the market place. It is critical that a suitable resilient acoustic mount be selected in order for wall, floor or roof construction to achieve the acoustic rating. Good quality resilient acoustic mounts should be selected and loaded appropriately to ensure that static deflection is sufficient to achieve good acoustic performance. A suitable static deflection is typically around 5mm. Rondo and Embelton supply suitable resilient acoustic mounts.

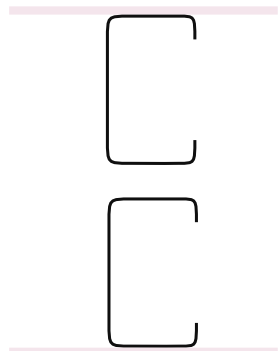
ACOUSTIC CONCEPTS

CONTINUOUS CONSTRUCTION



GTEK-S001

DISCONTINUOUS CONSTRUCTION



GTEK-SD019

QUALITY CONSTRUCTIONS / GENERAL DETAILING

Quality on-site construction is critical to achieve a good level of acoustic performance in any building project. Small gaps and holes can often occur in and around a wall. If these are left untreated they significantly down-rate the acoustic performance. Any gaps and holes must be minimised. Gaps and holes which do occur, including those around services penetrations, should be acoustically sealed to minimise the leakage effect on acoustic performance.

ACOUSTIC RATINGS

Acoustic ratings in this Guide have been prepared by Marshall Day Acoustics Pty Ltd. Acoustic ratings have been developed based upon laboratory test data for GTEK™ wall and floor systems, other available laboratory data for comparable constructions and calculations based on theoretical models. Ratings are expected to be accurate to within ± 2.5 Rw.

## GLOSSARY OF ACOUSTIC TERMS

<b>dB</b>	Decibel. The unit of sound level.
<b>NOISE</b>	Unwanted sound.
<b>SOUND INSULATION or SOUND REDUCTION</b>	When sound hits a surface, some of the sound energy travels through the material. 'Sound insulation or sound reduction' refers to ability of a material to stop sound travelling through it.
<b>R<sub>w</sub></b>	Weighted sound reduction index. A single number rating of the sound insulation performance of a specific building element such as a wall or floor. R <sub>w</sub> is measured in a laboratory.
<b>D<sub>nT,w</sub></b>	Weighted standardised level difference. A single number rating of the sound level difference between two rooms. D <sub>nT,w</sub> is typically used to measure on-site sound insulation performance of building elements such as a walls or floors.  The on-site D <sub>nT,w</sub> value is typically about 5 points less than the laboratory R <sub>w</sub> value.
<b>C<sub>tr</sub></b>	C <sub>tr</sub> is a sound insulation adjustment, commonly used with R <sub>w</sub> and D <sub>nT,w</sub> . C <sub>tr</sub> adjusts for low frequency noise, such as noise from trucks and subwoofers. C <sub>tr</sub> values typically range from about -4 to about -12.
<b>R<sub>w</sub>+C<sub>tr</sub></b>	The combined value of Weighted sound reduction index R <sub>w</sub> + Spectrum adaptation term C <sub>tr</sub> . A single number rating of the sound insulation performance of a building element with the C <sub>tr</sub> correction included R <sub>w</sub> +C <sub>tr</sub> values are measured in the laboratory and are lower than R <sub>w</sub> values.
<b>D<sub>nT,w</sub>+C<sub>tr</sub></b>	The combined value of Weighted standardised level difference D <sub>nT,w</sub> + spectrum adaptation term C <sub>tr</sub> . A single number rating of the sound level difference between two rooms with the C <sub>tr</sub> correction included. D <sub>nT,w</sub> +C <sub>tr</sub> is used to measure on-site sound insulation performance of building elements such as a walls or floors D <sub>nT,w</sub> +C <sub>tr</sub> values are lower than D <sub>nT,w</sub> values.
<b>FLANKING</b>	Transmission of sound energy through paths adjacent to the building element being considered. For example, sound may be transmitted around a wall by travelling up into the ceiling space and then down into the adjacent room.
<b>STRUCTURE-BORNE TRANSMISSION</b>	Transmission of sound energy as vibrations inside the structure of a building.
<b>STC (SOUND TRANSMISSION CLASS)</b>	A measure of the sound insulation performance of a building element. It is measured in very controlled conditions in a laboratory. STC is no longer in common use in Australia.

## GTEK™ FIRE PARTITION SYSTEMS

**INTRODUCTION**

GTEK™ fire-rated systems consist of single or multiple layers of GTEK™ Fire, screw-fixed to steel framing and nail or screw fixed to timber stud framing.

GTEK™ Fire is manufactured to the requirements of Australian Standards AS/NZS 2588:1998 - "Gypsum plasterboard" and must be installed in accordance with the Australian Standards AS/NZS 2589:2007 Gypsum linings - Application and Finishing.

GTEK™ fire rated systems have been tested according to AS/NZS 3837: 1998 and AS/NZS 1530.4, by NATA accredited testing laboratories.

GTEK™ Fire has a light-pink facing liner board and GTEK™ Fire & Wet Area has a blue/grey facing liner board for easy identification and is available in 13mm and 16mm thicknesses with recessed edges, ready for taping and jointing with proprietary jointing materials.

**EARLY FIRE HAZARD INDICES**

GTEK™ Fire complies with the National Construction Code (NCC) Material Group Number Classification and Deemed to Satisfy Provisions, as determined by AS/NZS 3837: 1998 tests.

- ▶ Material Classification: Group 1. (NCC) Specification A2.4)
- ▶ Suitability as Wall and Ceiling Lining In Fire-Isolated Exits, Public Corridors, Specified and Other Areas. (NCC Specification C1.10a Section 3(c) and Table 2: Wall and Ceiling Linings Material Groups Permitted.
- ▶ CSIRO BCE Certificate No 482

**APPLICATION**

GTEK™ Fire systems are suitable for industrial, commercial and residential applications, both in the new construction and renovation sectors.

Load bearing, non-load bearing walls and partitions can be clad with single or multiple layers of GTEK™ Fire, with or without cavity infill insulation, to achieve the required results for fire resistance: FRL and acoustic properties: RW.

**NON-LOAD BEARING WALLS**

The maximum wall heights for non-load bearing fire rated walls, in this Installation Guide are for laterally loaded walls of 0.25 kPa and 0.35 kPa, as set out in the Rondo Tables on page 11.

The maximum stud height is based H/240 or 30mm maximum deflection, to comply with NCC 2004 Specification 1.8 Clause 3.4.

**LOAD BEARING WALLS**

Load bearing walls in this Installation Guide must be designed and constructed in accordance with AS 1684 and AS 1720, for timber construction and AS/NZS 4600 and AS 3623 for light-weight Cold-Formed-Steel (CFS) construction.

Load bearing walls must be designed and constructed to take all loads without any cladding or lining.

**INSTALLATION**

Installation is to be in accordance with AS/NZS 2589:2007 Gypsum linings - Application and Finishing and as set out in this manual.

All fire rated plasterboard must be mechanically fastener fixed to steel or timber framing. Stud adhesive must not be used.

For multiple layered systems all joints must be staggered and butt joints in the outer layer may be reinforced with laminating screws.

The final layer in all Fire and Acoustic systems is required to be jointed and finished to a minimum level 3 finish to achieve the stated FRL. This includes boundary wall systems.

All perimeter gaps and penetrations must be fully sealed with an AS/NZS approved fire rated mastic sealant, to attain the required FRL and RW ratings.

FIRE RESISTANCE TERMS AND DEFINITIONS

**FIRE RESISTANCE LEVEL (FRL)**

The nominal grading period, in minutes, that is determined by subjecting a specimen to the standard time temperature curve regime as set out in AS1530.4.

This is to specify—

- (a) Structural adequacy
- (b) Integrity
- (c) Insulation

These are expressed in that order. Refer to the example below

60/60/60. This indicates that it is a loadbearing system as it has a figure (60) in the first area (Structural adequacy)

-/60/60. This indicates that it is a non loadbearing system as it has no figure (-) in the first area (Structural adequacy)

The definitions as set out in the Standard are below:

**STRUCTURAL ADEQUACY**

The ability of a load-bearing element of construction to support a load when tested in accordance with AS1530.4.

Eg: 60/60/60

**INTEGRITY**

The ability of an element of construction to resist the passage of flames and hot gases from one space to another, when tested in accordance with AS1530.4.

Eg: 60/60/60

**INSULATION**

The ability of an element of construction to maintain a temperature on the surface that is not exposed to the furnace, below the limits specified, when tested in accordance with AS1530.4.

Eg: 60/60/60

This means that during a fire test, the system did not fail for 60 minutes for each of the criteria.

Ensure fasteners used to fix top and bottom track are appropriate for the Uniform Distributed Loads (UDL) on walls.

At 600mm fastener centres and a UDL of 0.25kPa, the fasteners must withstand a shear load of 0.75kN.

At 600mm fastener centres and a UDL of 0.35kPa, the fasteners must withstand a shear load of 1.1kN.

Below is the standard time vs temperature table which is represented in the **STANDARD TIME VS TEMPERATURE CURVE**.

This shows the rise in temperature vs the associated time.

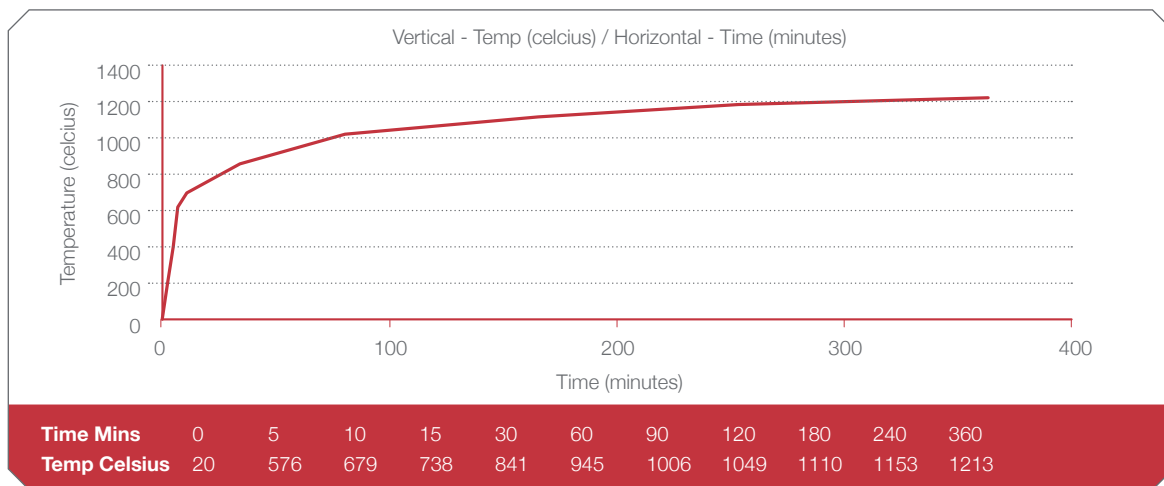
As indicated, in 5 minutes the temperature in the test facility has risen to 576 degrees Celsius, in 15 minutes 738 degrees Celsius and 90 minutes over 1,000 degrees Celsius and so on.

Where a wall or ceiling is required to meet the various requirements under the BCA it is the job of the Fireboard and the framing to prevent the flames, smoke and temperature from getting through to the other side.

For example, where there is a wall required to achieve a -/120/120 system number SO21 shows 2 layers of 13mm GTEK™ Fire both sides of a metal stud. Effectively overall there is 52mm of fire rated plasterboard and framing to stop a peak of over 1,000 degrees of heat reaching through to the other side for a period of 2 hours.

**RISF Resistance to the incipient spread of fire (in respect of a ceiling membrane)**

The ability of the membrane to insulate the space between the ceiling and roof, or ceiling and floor above, so as to limit the temperature rise of materials in this space to a level that will not permit the rapid and general spread of fire throughout the space to adjoining fire compartments.



## GTEK™ FIRE PARTITION SYSTEMS

**CONTROL JOINTS**

A joint between or within discrete elements of construction, which allows for relative movement of the elements.

Control joints can allow for a degree of building movement which can result from such things as moisture, loads, structural movement and foundation settlement etc. Cracks in plasterboard and plasterboard joints should be eliminated by using control joints and the correct installation techniques. Control joints must be installed in plasterboard walls and ceilings at:

- ▶ Maximum 12 metre intervals
- ▶ Control joints in the structure
- ▶ Any change in the substrate material
- ▶ Junctions of dissimilar structural products
- ▶ When long runs of plasterboard meet at right angle (change of direction)

Distance between control joints may need to be minimised to less than 12 metres due to on site conditions such as humidity or temperature variations or where ever excessive structural movement is likely to occur.

**ACCEPTABLE VARIATIONS TO FIRE RATED SYSTEMS**

Fire rated systems must be built according to GTEK™ installation instructions. However, there are some variations allowed that will not degrade the performance of the system:

- ▶ Increasing the width of the cavity (between stud walls in a double stud wall system)
- ▶ Increasing the stud size or the metal thickness
- ▶ Adding noggings to support fixtures or services
- ▶ Decreasing stud spacing (increasing amount of studs)
- ▶ Additional fasteners

**MODIFICATIONS TO FIRE RATED SYSTEMS**

Fire rated systems may be modified by the installation of the following examples but not limited to these:

- ▶ Fire rated inspection hatches
- ▶ Fire rated power points
- ▶ Fire rated light fittings
- ▶ Fire rated doors

It is the responsibility of the manufacturer of additional components in a fire system to ensure that the fire and acoustic properties of the plasterboard system are maintained. Any modification not covered in this manual must be according to the relevant manufacturer's instructions.





STEEL FRAME INTERIOR WALL SYSTEM – SINGLE STUD



STEEL STUDS AT 600mm MAX CENTRES

Side 1 1 x 10mm GTEK™ Wall  
Side 2 1 x 10mm GTEK™ Wall

GTEK-S001

FRL	STUD DEPTH mm	51	64	76	92	150
	CAVITY INFILL	Rw/Rw+Ctr				
- / - / -	Nil	30/25	31/25	31/26	32/26	33/27
	9kg - 50mm Glasswool	38/29	39/29	40/30	41/31	43/34
	30kg - 75mm Glasswool	-	-	40/30	42/31	44/34
	<b>WALL THICKNESS mm</b>	<b>71</b>	<b>84</b>	<b>96</b>	<b>112</b>	<b>170</b>



STEEL STUDS AT 600mm MAX CENTRES

Side 1 1 x 13mm GTEK™ Wall  
Side 2 1 x 13mm GTEK™ Wall

GTEK-S002

FRL	STUD DEPTH mm	51	64	76	92	150
	CAVITY INFILL	Rw/Rw+Ctr				
- / - / -	Nil	33/28	34/28	34/28	35/29	37/31
	9kg - 50mm Glasswool	41/31	42/32	43/32	44/33	46/37
	30kg - 75mm Glasswool	-	-	44/32	45/34	47/37
	<b>WALL THICKNESS mm</b>	<b>77</b>	<b>90</b>	<b>102</b>	<b>118</b>	<b>176</b>



STEEL STUDS AT 600mm MAX CENTRES

Side 1 2 x 13mm GTEK™ Wall  
Side 2 1 x 13mm GTEK™ Wall

GTEK-S003

FRL	STUD DEPTH mm	51	64	76	92	150
	CAVITY INFILL	Rw/Rw+Ctr				
- / - / -	Nil	38/32	38/32	39/32	40/33	42/34
	9kg - 50mm Glasswool	45/34	46/34	47/37	49/40	49/41
	30kg - 75mm Glasswool	-	-	48/37	49/40	49/42
	<b>WALL THICKNESS mm</b>	<b>90</b>	<b>103</b>	<b>115</b>	<b>131</b>	<b>189</b>

STEEL FRAME INTERIOR WALL SYSTEM – SINGLE STUD



**STEEL STUDS AT 600mm MAX CENTRES**

Side 1 2 x 13mm GTEK™ Wall  
Side 2 2 x 13mm GTEK™ Wall

**GTEK-S005**

FRL	STUD DEPTH mm	51	64	76	92	150
	CAVITY INFILL	Rw/Rw+Ctr				
- / - / -	Nil	41/34	42/33	43/37	44/37	46/38
	9kg - 50mm Glasswool	49/38	50/41	52/43	53/45	55/48
	30kg - 75mm Glasswool	-	-	53/43	54/46	55/48
	<b>WALL THICKNESS mm</b>	<b>103</b>	<b>116</b>	<b>128</b>	<b>144</b>	<b>202</b>



**STEEL STUDS AT 600mm MAX CENTRES**

Side 1 1 x 10mm GTEK™ Sound  
Side 2 1 x 10mm GTEK™ Sound

**GTEK-S006**

FRL	STUD DEPTH mm	51	64	76	92	150
	CAVITY INFILL	Rw/Rw+Ctr				
- / - / -	Nil	33/28	35/29	35/29	36/29	38/31
	9kg - 50mm Glasswool	41/31	42/32	44/33	44/34	47/38
	30kg - 75mm Glasswool	-	-	44/33	45/34	48/39
	<b>WALL THICKNESS mm</b>	<b>71</b>	<b>84</b>	<b>96</b>	<b>112</b>	<b>170</b>



**STEEL STUDS AT 600mm MAX CENTRES**

Side 1 1 x 13mm GTEK™ Sound  
Side 2 1 x 13mm GTEK™ Sound

**GTEK-S007**

FRL	STUD DEPTH mm	51	64	76	92	150
	CAVITY INFILL	Rw/Rw+Ctr				
- / - / -	Nil	36/31	37/31	38/32	39/33	41/34
	9kg - 50mm Glasswool	44/33	45/34	46/37	46/38	48/42
	30kg - 75mm Glasswool	-	-	46/38	47/38	49/43
	<b>WALL THICKNESS mm</b>	<b>77</b>	<b>90</b>	<b>102</b>	<b>118</b>	<b>176</b>

STEEL FRAME INTERIOR WALL SYSTEM – SINGLE STUD



STEEL STUDS AT 600mm MAX CENTRES

Side 1 2 x 10mm GTEK™ Sound  
Side 2 1 x 10mm GTEK™ Wet Area

GTEK-S009

FRL	STUD DEPTH mm	51	64	76	92	150
	CAVITY INFILL	Rw/Rw+Ctr				
- / - / -	Nil	38/32	38/32	39/32	40/33	42/34
	9kg - 50mm Glasswool	44/34	46/34	47/36	48/39	49/41
	30kg - 75mm Glasswool	-	-	47/36	49/39	49/41
	<b>WALL THICKNESS mm</b>	<b>81</b>	<b>94</b>	<b>106</b>	<b>122</b>	<b>180</b>



STEEL STUDS AT 600mm MAX CENTRES

Side 1 2 x 10mm GTEK™ Sound  
Side 2 2 x 10mm GTEK™ Sound

GTEK-S010

FRL	STUD DEPTH mm	51	64	76	92	150
	CAVITY INFILL	Rw/Rw+Ctr				
- / - / -	Nil	42/34	43/36	44/37	44/37	46/38
	9kg - 50mm Glasswool	50/40	52/41	53/43	54/46	55/48
	30kg - 75mm Glasswool	-	-	53/44	54/46	55/49
	<b>WALL THICKNESS mm</b>	<b>91</b>	<b>104</b>	<b>116</b>	<b>132</b>	<b>190</b>



STEEL STUDS AT 600mm MAX CENTRES

Side 1 1 x 13mm GTEK™ Fire  
Side 2 1 x 13mm GTEK™ Fire

GTEK-S011

FRL	STUD DEPTH mm	51	64	76	92	150
	CAVITY INFILL	Rw/Rw+Ctr				
- / 60 / 60	Nil	34/29	35/29	36/30	37/31	39/33
	9kg - 50mm Glasswool	42/32	43/32	44/33	45/36	47/40
	30kg - 75mm Glasswool	-	-	44/34	46/37	48/41
	<b>WALL THICKNESS mm</b>	<b>77</b>	<b>90</b>	<b>102</b>	<b>118</b>	<b>176</b>

STEEL FRAME INTERIOR WALL SYSTEM – SINGLE STUD



STEEL STUDS AT 600mm MAX CENTRES

Side 1 1 x 13mm GTEK™ Fire  
 1 x 10mm GTEK™ Wall  
 Side 2 1 x 13mm GTEK™ Fire

GTEK-S012

FRL	STUD DEPTH mm	51	64	76	92	150
	CAVITY INFILL	Rw/Rw+Ctr				
-/60/60	Nil	38/33	39/33	40/33	41/34	43/35
	9kg - 50mm Glasswool	46/34	47/36	48/39	49/39	50/42
	30kg - 75mm Glasswool	-	-	49/39	49/39	50/42
	<b>WALL THICKNESS mm</b>	<b>87</b>	<b>100</b>	<b>112</b>	<b>128</b>	<b>186</b>



STEEL STUDS AT 600mm MAX CENTRES

Side 1 1 x 13mm GTEK™ Fire  
 Side 2 2 x 13mm GTEK™ Fire

GTEK-S018

FRL	STUD DEPTH mm	51	64	76	92	150
	CAVITY INFILL	Rw/Rw+Ctr				
-/60/60	Nil	39/33	40/33	40/34	41/35	43/37
	9kg - 50mm Glasswool	47/35	48/38	49/41	50/41	52/44
	30kg - 75mm Glasswool	-	-	49/41	51/42	52/45
	<b>WALL THICKNESS mm</b>	<b>87</b>	<b>100</b>	<b>112</b>	<b>128</b>	<b>186</b>



STEEL STUDS AT 600mm MAX CENTRES

Side 1 1 x 16mm GTEK™ Fire  
 Side 2 1 x 16mm GTEK™ Fire

Refer to P63 for fixing details

Previously BGC003

GTEK-S019

FRL	STUD DEPTH mm	51	64	76	92	150
	CAVITY INFILL	Rw/Rw+Ctr				
-/60/60 60/60/60	Nil	36/31	37/31	38/32	39/33	41/34
	9kg - 50mm Glasswool	44/33	45/34	46/37	46/38	48/42
	30kg - 75mm Glasswool	-	-	46/38	47/38	49/43
	<b>WALL THICKNESS mm</b>	<b>83</b>	<b>96</b>	<b>108</b>	<b>124</b>	<b>182</b>

STEEL FRAME INTERIOR WALL SYSTEM – SINGLE STUD



STEEL STUDS AT 600mm MAX CENTRES

Side 1 2 x 13mm GTEK™ Fire  
Side 2 2 x 13mm GTEK™ Fire

Previously BGC002

GTEK-S021

FRL	STUD DEPTH mm	51	64	76	92	150
	CAVITY INFILL	Rw/Rw+Ctr				
-/120/120 90/90/90	Nil	43/36	44/38	45/39	46/39	48/41
	9kg - 50mm Glasswool	50/42	52/43	54/46	54/47	56/49
	30kg - 75mm Glasswool	-	-	54/47	55/48	56/49
	<b>WALL THICKNESS mm</b>	<b>103</b>	<b>116</b>	<b>128</b>	<b>144</b>	<b>202</b>



STEEL STUDS AT 600mm MAX CENTRES

Side 1 2 x 16mm GTEK™ Fire  
Side 2 2 x 16mm GTEK™ Fire

Previously BGC004

GTEK-S023

FRL	STUD DEPTH mm	51	64	76	92	150
	CAVITY INFILL	Rw/Rw+Ctr				
-/120/120 120/120/120	Nil	45/38	47/40	47/39	48/40	50/42
	9kg - 50mm Glasswool	53/43	54/46	55/47	55/48	56/49
	30kg - 75mm Glasswool	-	-	55/47	56/49	56/49
	<b>WALL THICKNESS mm</b>	<b>115</b>	<b>128</b>	<b>140</b>	<b>156</b>	<b>214</b>



STEEL STUDS AT 600mm MAX CENTRES

Side 1 3 x 13mm GTEK™ Fire  
Side 2 3 x 13mm GTEK™ Fire

GTEK-S025

FRL	STUD DEPTH mm	51	64	76	92	150
	CAVITY INFILL	Rw/Rw+Ctr				
-/120/120 90/90/90	Nil	47/41	48/41	49/42	50/43	53/45
	9kg - 50mm Glasswool	57/49	57/50	58/51	58/52	59/54
	30kg - 75mm Glasswool	-	-	58/52	58/53	59/55
	<b>WALL THICKNESS mm</b>	<b>129</b>	<b>142</b>	<b>154</b>	<b>170</b>	<b>228</b>

STEEL FRAME INTERIOR WALL SYSTEM – SINGLE STUD



STEEL STUDS AT 600mm MAX CENTRES

Side 1 3 x 16mm GTEK™ Fire  
Side 2 3 x 16mm GTEK™ Fire

GTEK-S026

FRL	STUD DEPTH mm	51	64	76	92	150
	CAVITY INFILL	Rw/Rw+Ctr				
- /180/180 120/120/120	Nil	50/43	51/44	51/44	52/45	54/46
	9kg - 50mm Glasswool	58/49	58/51	58/53	59/54	59/56
	30kg - 75mm Glasswool	-	-	59/54	59/54	59/56
	<b>WALL THICKNESS mm</b>	<b>147</b>	<b>160</b>	<b>172</b>	<b>188</b>	<b>246</b>



STEEL STUDS AT 600mm MAX CENTRES

Side 1 1 x 6mm BGC Duraliner™ Plus  
Side 2 1 x 6mm BGC Duraliner™ Plus

GTEK-S027

FRL	STUD DEPTH mm	51	64	76	92	150
	CAVITY INFILL	Rw/Rw+Ctr				
- /- /-	Nil	32/26	33/26	33/26	33/27	35/28
	9kg - 50mm Glasswool	41/31	41/31	43/32	44/32	46/35
	30kg - 75mm Glasswool	-	-	43/32	44/32	46/35
	<b>WALL THICKNESS mm</b>	<b>63</b>	<b>76</b>	<b>88</b>	<b>104</b>	<b>162</b>



STEEL STUDS AT 600mm MAX CENTRES

Side 1 1 x 9mm BGC Duraliner™ Plus  
Side 2 1 x 9mm BGC Duraliner™ Plus

GTEK-S028

FRL	STUD DEPTH mm	51	64	76	92	150
	CAVITY INFILL	Rw/Rw+Ctr				
- /- /-	Nil	39/32	40/33	41/33	41/34	42/34
	9kg - 50mm Glasswool	45/33	47/35	48/37	49/38	49/42
	30kg - 75mm Glasswool	-	-	49/37	49/38	49/43
	<b>WALL THICKNESS mm</b>	<b>69</b>	<b>82</b>	<b>94</b>	<b>110</b>	<b>168</b>

STEEL FRAME INTERIOR WALL SYSTEM – SINGLE STUD



STEEL STUDS AT 600mm MAX CENTRES

Side 1 1 x 12mm BGC Duraliner™ Plus  
Side 2 1 x 12mm BGC Duraliner™ Plus

GTEK-S029

FRL	STUD DEPTH mm	51	64	76	92	150
	CAVITY INFILL	Rw/Rw+Ctr				
-/-/-	Nil	40/33	40/33	41/35	43/36	44/37
	9kg - 50mm Glasswool	48/36	49/40	49/40	52/44	54/47
	30kg - 75mm Glasswool	-	-	49/40	53/44	54/47
	<b>WALL THICKNESS mm</b>	<b>75</b>	<b>88</b>	<b>100</b>	<b>116</b>	<b>174</b>



STEEL STUDS AT 600mm MAX CENTRES

Side 1 1 x 10mm GTEK™ Sound  
Side 2 1 x 6mm BGC Duraliner™ Plus

GTEK-S031

FRL	STUD DEPTH mm	51	64	76	92	150
	CAVITY INFILL	Rw/Rw+Ctr				
-/-/-	Nil	34/28	35/29	35/28	36/29	38/31
	9kg - 50mm Glasswool	41/31	42/32	44/32	44/33	46/36
	30kg - 75mm Glasswool	-	-	44/32	45/33	47/37
	<b>WALL THICKNESS mm</b>	<b>67</b>	<b>80</b>	<b>92</b>	<b>108</b>	<b>166</b>



STEEL STUDS AT 600mm MAX CENTRES

Side 1 1 x 13mm GTEK™ Wall  
Side 2 1 x 6mm BGC Duraliner™ Plus

GTEK-S033

FRL	STUD DEPTH mm	51	64	76	92	150
	CAVITY INFILL	Rw/Rw+Ctr				
-/-/-	Nil	34/28	35/28	35/28	36/29	38/31
	9kg - 50mm Glasswool	41/31	42/31	43/32	44/33	46/36
	30kg - 75mm Glasswool	-	-	44/32	45/33	47/37
	<b>WALL THICKNESS mm</b>	<b>70</b>	<b>83</b>	<b>95</b>	<b>111</b>	<b>169</b>

STEEL FRAME INTERIOR WALL SYSTEM – SINGLE STUD



**STEEL STUDS AT 600mm MAX CENTRES**

Side 1 1 x 13mm GTEK™ Wall  
Side 2 1 x 9mm BGC Duraliner™ Plus

**GTEK-S034**

FRL	STUD DEPTH mm	51	64	76	92	150
	CAVITY INFILL	Rw/Rw+Ctr				
-/-/-	Nil	36/30	36/30	37/31	38/31	41/34
	9kg - 50mm Glasswool	42/32	44/33	45/34	46/36	49/40
	30kg - 75mm Glasswool	-	-	46/34	47/37	49/40
	<b>WALL THICKNESS mm</b>	<b>73</b>	<b>86</b>	<b>98</b>	<b>114</b>	<b>172</b>



**STEEL STUDS AT 600mm MAX CENTRES**

Side 1 1 x 13mm GTEK™ Fire  
Side 2 1 x 6mm BGC Duraliner™ Plus

**GTEK-S035**

FRL	STUD DEPTH mm	51	64	76	92	150
	CAVITY INFILL	Rw/Rw+Ctr				
-/-/-	Nil	34/28	35/28	35/28	36/29	38/31
	9kg - 50mm Glasswool	41/31	43/32	45/33	46/35	49/39
	30kg - 75mm Glasswool	-	-	45/33	46/35	49/40
	<b>WALL THICKNESS mm</b>	<b>70</b>	<b>83</b>	<b>95</b>	<b>111</b>	<b>169</b>



**STEEL STUDS AT 600mm MAX CENTRES**

Side 1 1 x 16mm GTEK™ Fire (against studs)  
1 x 9mm BGC Duraliner™ Plus  
Side 2 1 x 16mm GTEK™ Fire (against studs)  
1 x 9mm BGC Duraliner™ Plus

**GTEK-S041**

FRL	STUD DEPTH mm	51	64	76	92	150
	CAVITY INFILL	Rw/Rw+Ctr				
60/60/60 -/120/120	Nil	45/38	47/40	47/39	48/40	50/42
	9kg - 50mm Glasswool	53/43	54/46	55/47	55/48	56/49
	30kg - 75mm Glasswool	-	-	55/47	56/49	56/49
	<b>WALL THICKNESS mm</b>	<b>73</b>	<b>86</b>	<b>98</b>	<b>114</b>	<b>172</b>



STEEL FRAME INTERIOR WALL SYSTEM – SINGLE STUD



**STEEL STUDS AT 600mm MAX CENTRES**  
 Side 1 1 x 13mm GTEK™ Fire (against studs)  
 1 x 6mm BGC Duraliner™ Plus  
 Side 2 1 x 13mm GTEK™ Fire (against studs)  
 1 x 6mm BGC Duraliner™ Plus

**GTEK-S042**

FRL	STUD DEPTH mm	51	64	76	92	150
	CAVITY INFILL	Rw/Rw+Ctr				
-/90/90	Nil	45/38	45/38	46/39	47/39	49/41
	9kg - 50mm Glasswool	54/44	56/47	56/47	57/49	58/52
	30kg - 75mm Glasswool	-	-	56/47	57/49	58/52
	<b>WALL THICKNESS mm</b>	<b>73</b>	<b>86</b>	<b>98</b>	<b>114</b>	<b>172</b>



**STEEL STUDS AT 600mm MAX CENTRES**  
 Side 1 1 x 9mm BGC Duraliner™ Plus (against studs)  
 1 x 16mm GTEK™ Fire  
 Side 2 1 x 9mm BGC Duraliner™ Plus (against studs)  
 1 x 16mm GTEK™ Fire

Previously BGC DL001

**GTEK-S043**

FRL	STUD DEPTH mm	51	64	76	92	150
	CAVITY INFILL	Rw/Rw+Ctr				
-/120/120	Nil	45/38	47/40	47/39	48/40	50/42
	9kg - 50mm Glasswool	53/43	54/46	55/47	55/48	56/49
	30kg - 75mm Glasswool	-	-	55/47	56/49	56/49
	<b>WALL THICKNESS mm</b>	<b>73</b>	<b>86</b>	<b>98</b>	<b>114</b>	<b>172</b>



**STEEL STUDS AT 600mm MAX CENTRES**  
 Side 1 2 x 16mm GTEK™ Fire & Wet Area  
 Side 2 2 x 16mm GTEK™ Fire & Wet Area

**GTEK-S044**

FRL	STUD DEPTH mm	51	64	76	92	150
	CAVITY INFILL	Rw/Rw+Ctr				
-/180/180 120/120/120	Nil	45/38	47/40	47/39	48/40	50/42
	9kg - 50mm Glasswool	53/43	54/46	55/47	55/48	56/49
	30kg - 75mm Glasswool	-	-	55/47	56/49	56/49
	<b>WALL THICKNESS mm</b>	<b>73</b>	<b>86</b>	<b>98</b>	<b>114</b>	<b>172</b>

STEEL FRAME INTERIOR WALL SYSTEM – SINGLE STUD



STEEL STUDS AT 600mm MAX CENTRES

Side 1 1 x 13mm GTEK™ Total Plus  
Side 2 1 x 13mm GTEK™ Total Plus

GTEK-E5S001

FRL	STUD DEPTH mm	51	64	76	92	150
	CAVITY INFILL	Rw/Rw+Ctr				
-/60/60	Nil	36/30	37/30	38/31	39/32	41/33
	9kg - 50mm Glasswool	43/32	44/33	45/36	46/37	48/41
	11kg - 75mm Glasswool	43/32	44/33	45/36	46/37	48/41
	30kg - 75mm Glasswool	44/33	45/35	46/38	47/38	49/43
	<b>WALL THICKNESS mm</b>	<b>73</b>	<b>86</b>	<b>98</b>	<b>114</b>	<b>172</b>



STEEL STUDS AT 600mm MAX CENTRES

Side 1 1 x 13mm GTEK™ Total Plus  
Side 2 2 x 13mm GTEK™ Total Plus

GTEK-E5S002

FRL	STUD DEPTH mm	51	64	76	92	150
	CAVITY INFILL	Rw/Rw+Ctr				
-/60/60	Nil	40/34	41/34	41/35	42/36	44/38
	9kg - 50mm Glasswool	47/36	49/39	50/42	51/42	52/42
	11kg - 75mm Glasswool	47/36	49/39	50/42	51/42	52/45
	30kg - 75mm Glasswool	47/37	49/40	50/42	52/43	53/45
	<b>WALL THICKNESS mm</b>	<b>73</b>	<b>86</b>	<b>98</b>	<b>114</b>	<b>172</b>



STEEL STUDS AT 600mm MAX CENTRES

Side 1 2 x 13mm GTEK™ Total Plus  
Side 2 2 x 13mm GTEK™ Total Plus

GTEK-E5S003

FRL	STUD DEPTH mm	51	64	76	92	150
	CAVITY INFILL	Rw/Rw+Ctr				
-/120/120	Nil	45/38	47/40	47/39	48/40	50/42
	9kg - 50mm Glasswool	53/44	54/46	55/47	55/48	56/49
	11kg - 75mm Glasswool	53/44	54/46	55/47	55/48	56/49
	30kg - 75mm Glasswool	54/45	55/47	55/48	56/49	56/49
	<b>WALL THICKNESS mm</b>	<b>73</b>	<b>86</b>	<b>98</b>	<b>114</b>	<b>172</b>

STEEL FRAME INTERIOR WALL SYSTEM – SINGLE STUD



STEEL STUDS AT 600mm MAX CENTRES

Side 1  
Side 2 3 x 16mm GTEK™ Fire & Wet Area

GTEK-S045

FRL	STUD DEPTH mm	51	64	76	92	150
	CAVITY INFILL	Rw/Rw+Ctr				
-/120/120 120/120/120	Nil	38/36	-	-	-	-
	9kg - 50mm Glasswool	-	-	-	-	-
	30kg - 75mm Glasswool	-	-	-	-	-
	<b>WALL THICKNESS mm</b>	<b>99</b>	<b>112</b>	<b>124</b>	<b>140</b>	<b>198</b>



STEEL STUDS AT 600mm MAX CENTRES

Side 1  
Side 2 2 x 16mm GTEK™ Fire

GTEK-S046

FRL	STUD DEPTH mm	51	64	76	92	150
	CAVITY INFILL	Rw/Rw+Ctr				
-/60/60	Nil	35/32	-	-	-	-
	9kg - 50mm Glasswool	-	-	-	-	-
	30kg - 75mm Glasswool	-	-	-	-	-
	<b>WALL THICKNESS mm</b>	<b>83</b>	<b>96</b>	<b>108</b>	<b>124</b>	<b>182</b>



STEEL STUDS AT 600mm MAX CENTRES

Side 1  
Side 2 3 x 16mm GTEK™ Fire

GTEK-S048

FRL	STUD DEPTH mm	51	64	76	92	150
	CAVITY INFILL	Rw/Rw+Ctr				
-/120/120 120/120/120	Nil	38/36	-	-	-	-
	9kg - 50mm Glasswool	-	-	-	-	-
	30kg - 75mm Glasswool	-	-	-	-	-
	<b>WALL THICKNESS mm</b>	<b>99</b>	<b>112</b>	<b>124</b>	<b>140</b>	<b>198</b>

STEEL FRAME INTERIOR WALL SYSTEM – SINGLE STUD



**STEEL STUDS AT 600mm MAX CENTRES**

Side 1

Side 2 3 x 13mm GTEK™ Fire

**GTEK-S049**

FRL	STUD DEPTH mm	51	64	76	92	150
	CAVITY INFILL	Rw/Rw+Ctr				
90/90/90	Nil	-	-	-	-	-
	9kg - 50mm Glasswool	-	-	-	-	-
	30kg - 75mm Glasswool	-	-	-	-	-
	<b>WALL THICKNESS mm</b>	90	103	115	131	189

STEEL FRAME INTERIOR WALL SYSTEM – STAGGERED STUD



STAGGERED STEEL STUDS AT 600mm MAX CENTRES

Side 1 1 x 10mm GTEK™ Wall  
Side 2 1 x 10mm GTEK™ Wall

GTEK-SS001

FRL	CAVITY WIDTH mm	76	92	150
	CAVITY INFILL	Rw/Rw+Ctr		
-/-/-	Nil	33/27	33/27	34/28
	9kg - 50mm Glasswool	42/32	43/33	46/36
	30kg - 75mm Glasswool	42/32	44/33	47/37
	<b>WALL THICKNESS mm</b>	<b>96</b>	<b>112</b>	<b>170</b>



STAGGERED STEEL STUDS AT 600mm MAX CENTRES

Side 1 1 x 13mm GTEK™ Wall  
Side 2 1 x 13mm GTEK™ Wall

GTEK-SS002

FRL	CAVITY WIDTH mm	76	92	150
	CAVITY INFILL	Rw/Rw+Ctr		
-/-/-	Nil	36/30	37/31	39/33
	9kg - 50mm Glasswool	46/34	47/36	49/38
	30kg - 75mm Glasswool	46/34	47/36	49/38
	<b>WALL THICKNESS mm</b>	<b>102</b>	<b>118</b>	<b>176</b>



STAGGERED STEEL STUDS AT 600mm MAX CENTRES

Side 1 1 x 10mm GTEK™ Sound  
Side 2 1 x 10mm GTEK™ Sound

GTEK-SS006

FRL	CAVITY WIDTH mm	76	92	150
	CAVITY INFILL	Rw/Rw+Ctr		
-/-/-	Nil	36/30	37/30	39/32
	9kg - 50mm Glasswool	46/35	47/36	49/38
	30kg - 75mm Glasswool	47/35	48/36	49/38
	<b>WALL THICKNESS mm</b>	<b>96</b>	<b>112</b>	<b>170</b>

STEEL FRAME INTERIOR WALL SYSTEM – STAGGERED STUD



**STAGGERED STEEL STUDS AT 600mm MAX CENTRES**

Side 1 1 x 13mm GTEK™ Sound  
Side 2 1 x 13mm GTEK™ Sound

**GTEK-SS007**

FRL	CAVITY WIDTH mm	76	92	150
	CAVITY INFILL	Rw/Rw+Ctr		
-/-/-	Nil	38/32	39/33	41/34
	9kg - 50mm Glasswool	48/38	49/39	52/44
	30kg - 75mm Glasswool	9/38	50/39	53/45
	<b>WALL THICKNESS mm</b>	<b>102</b>	<b>118</b>	<b>176</b>



**STAGGERED STEEL STUDS AT 600mm MAX CENTRES**

Side 1 2 x 10mm GTEK™ Sound  
Side 2 2 x 10mm GTEK™ Sound

**GTEK-SS010**

FRL	CAVITY WIDTH mm	76	92	150
	CAVITY INFILL	Rw/Rw+Ctr		
-/-/-	Nil	46/39	46/39	49/41
	9kg - 50mm Glasswool	54/44	56/46	58/49
	30kg - 75mm Glasswool	55/44	57/47	59/50
	<b>WALL THICKNESS mm</b>	<b>116</b>	<b>132</b>	<b>190</b>



**STAGGERED STEEL STUDS AT 600mm MAX CENTRES**

Side 1 1 x 13mm GTEK™ Fire  
Side 2 1 x 13mm GTEK™ Fire

**GTEK-SS011**

FRL	CAVITY WIDTH mm	76	92	150
	CAVITY INFILL	Rw/Rw+Ctr		
-/60/60	Nil	38/32	39/33	41/35
	9kg - 50mm Glasswool	47/36	49/38	50/42
	30kg - 75mm Glasswool	48/36	49/38	51/42
	<b>WALL THICKNESS mm</b>	<b>102</b>	<b>118</b>	<b>176</b>

STEEL FRAME INTERIOR WALL SYSTEM – STAGGERED STUD



STAGGERED STEEL STUDS AT 600mm MAX CENTRES

Side 1 1 x 13mm GTEK™ Fire  
 1 x 13mm GTEK™ Wall  
 Side 2 1 x 13mm GTEK™ Fire

GTEK-SS014

FRL	CAVITY WIDTH mm	76	92	150
	CAVITY INFILL	Rw/Rw+Ctr		
-/60/60	Nil	40/33	42/36	44/37
	9kg - 50mm Glasswool	50/42	52/42	55/46
	30kg - 75mm Glasswool	50/42	54/42	56/47
	<b>WALL THICKNESS mm</b>	<b>115</b>	<b>131</b>	<b>189</b>



STAGGERED STEEL STUDS AT 600mm MAX CENTRES

Side 1 2 x 13mm GTEK™ Fire  
 Side 2 1 x 13mm GTEK™ Fire

GTEK-SS018

FRL	CAVITY WIDTH mm	76	92	150
	CAVITY INFILL	Rw/Rw+Ctr		
-/60/60	Nil	41/35	43/37	45/38
	9kg - 50mm Glasswool	52/43	53/43	55/47
	30kg - 75mm Glasswool	53/43	54/43	57/48
	<b>WALL THICKNESS mm</b>	<b>115</b>	<b>131</b>	<b>189</b>



STAGGERED STEEL STUDS AT 600mm MAX CENTRES

Side 1 1 x 16mm GTEK™ Fire  
 Side 2 1 x 16mm GTEK™ Fire

GTEK-SS019

FRL	CAVITY WIDTH mm	76	92	150
	CAVITY INFILL	Rw/Rw+Ctr		
-/60/60 60/60/60	Nil	38/32	39/33	41/34
	9kg - 50mm Glasswool	48/38	49/39	52/44
	30kg - 75mm Glasswool	49/38	50/39	53/45
	<b>WALL THICKNESS mm</b>	<b>108</b>	<b>124</b>	<b>182</b>

STEEL FRAME INTERIOR WALL SYSTEM – STAGGERED STUD



**STAGGERED STEEL STUDS AT 600mm MAX CENTRES**

Side 1 1 x 16mm GTEK™ Fire  
 1 x 13mm GTEK™ Fire  
 Side 2 1 x 16mm GTEK™ Fire

**GTEK-SS020**

FRL	CAVITY WIDTH mm	76	92	150
	CAVITY INFILL	Rw/Rw+Ctr		
-/60/60 60/60/60	Nil	43/36	44/38	46/39
	9kg - 50mm Glasswool	53/42	54/45	56/48
	30kg - 75mm Glasswool	54/43	55/45	57/49
	<b>WALL THICKNESS mm</b>	<b>121</b>	<b>137</b>	<b>195</b>



**STAGGERED STEEL STUDS AT 600mm MAX CENTRES**

Side 1 2 x 13mm GTEK™ Fire  
 Side 2 2 x 13mm GTEK™ Fire

**GTEK-SS021**

FRL	CAVITY WIDTH mm	76	92	150
	CAVITY INFILL	Rw/Rw+Ctr		
-/120/120 90/90/90	Nil	46/40	47/40	50/42
	9kg - 50mm Glasswool	56/46	57/48	59/52
	30kg - 75mm Glasswool	57/46	58/49	60/52
	<b>WALL THICKNESS mm</b>	<b>128</b>	<b>144</b>	<b>202</b>



**STAGGERED STEEL STUDS AT 600mm MAX CENTRES**

Side 1 2 x 16mm GTEK™ Fire  
 Side 2 2 x 16mm GTEK™ Fire

**GTEK-SS023**

FRL	CAVITY WIDTH mm	76	92	150
	CAVITY INFILL	Rw/Rw+Ctr		
-/120/120 120/120/120	Nil	47/40	48/41	51/43
	9kg - 50mm Glasswool	57/48	58/49	61/54
	30kg - 75mm Glasswool	58/49	59/50	61/54
	<b>WALL THICKNESS mm</b>	<b>140</b>	<b>156</b>	<b>214</b>



STEEL FRAME INTERIOR WALL SYSTEM – STAGGERED STUD



**STAGGERED STEEL STUDS AT 600mm MAX CENTRES**

Side 1 3 x 16mm GTEK™ Fire  
Side 2 3 x 16mm GTEK™ Fire

**GTEK-SS026**

FRL	CAVITY WIDTH mm	76	92	150
	CAVITY INFILL	Rw/Rw+Ctr		
-/180/180 120/120/120	Nil	50/42	51/43	54/45
	9kg - 50mm Glasswool	60/52	61/53	62/56
	30kg - 75mm Glasswool	61/53	61/54	62/57
	<b>WALL THICKNESS mm</b>	<b>172</b>	<b>188</b>	<b>246</b>



**STAGGERED STEEL STUDS AT 600mm MAX CENTRES**

Side 1 1 x 9mm BGC Duraliner™ Plus  
Side 2 1 x 9mm BGC Duraliner™ Plus

**GTEK-SS028**

FRL	CAVITY WIDTH mm	76	92	150
	CAVITY INFILL	Rw/Rw+Ctr		
-/-/-	Nil	39/31	39/32	41/33
	9kg - 50mm Glasswool	48/37	49/37	52/42
	30kg - 75mm Glasswool	49/37	50/38	54/43
	<b>WALL THICKNESS mm</b>	<b>94</b>	<b>110</b>	<b>168</b>



**STAGGERED STEEL STUDS AT 600mm MAX CENTRES**

Side 1 2 x 10mm GTEK™ Sound  
Side 2 1 x 6mm BGC Duraliner™ Plus

**GTEK-SS032**

FRL	CAVITY WIDTH mm	76	92	150
	CAVITY INFILL	Rw/Rw+Ctr		
-/-/-	Nil	39/32	39/32	41/33
	9kg - 50mm Glasswool	47/36	49/39	52/43
	30kg - 75mm Glasswool	49/37	50/39	54/43
	<b>WALL THICKNESS mm</b>	<b>102</b>	<b>118</b>	<b>176</b>

STEEL FRAME INTERIOR WALL SYSTEM – STAGGERED STUD



**STAGGERED STEEL STUDS AT 600mm MAX CENTRES**

Side 1 1 x 13mm GTEK™ Wall  
Side 2 1 x 6mm BGC Duraliner™ Plus

**GTEK-SS033**

FRL	CAVITY WIDTH mm	76	92	150
	CAVITY INFILL	Rw/Rw+Ctr		
-/-/-	Nil	35/28	36/29	38/31
	9kg - 50mm Glasswool	45/34	46/35	49/38
	30kg - 75mm Glasswool	46/34	47/35	49/38
	<b>WALL THICKNESS mm</b>	<b>95</b>	<b>111</b>	<b>169</b>



**STAGGERED STEEL STUDS AT 600mm MAX CENTRES**

Side 1 1 x 13mm GTEK™ Wall  
Side 2 1 x 9mm BGC Duraliner™ Plus

**GTEK-SS034**

FRL	CAVITY WIDTH mm	76	92	150
	CAVITY INFILL	Rw/Rw+Ctr		
-/-/-	Nil	38/32	39/32	42/35
	9kg - 50mm Glasswool	47/35	49/38	50/42
	30kg - 75mm Glasswool	48/36	49/38	51/40
	<b>WALL THICKNESS mm</b>	<b>98</b>	<b>114</b>	<b>172</b>



**STAGGERED STEEL STUDS AT 600mm MAX CENTRES**

Side 1 1 x 13mm GTEK™ Fire  
Side 2 1 x 6mm BGC Duraliner™ Plus

**GTEK-SS035**

FRL	CAVITY WIDTH mm	76	92	150
	CAVITY INFILL	Rw/Rw+Ctr		
-/-/-	Nil	36/29	37/30	39/32
	9kg - 50mm Glasswool	46/34	47/36	49/38
	30kg - 75mm Glasswool	47/34	48/36	49/38
	<b>WALL THICKNESS mm</b>	<b>95</b>	<b>111</b>	<b>169</b>

STEEL FRAME INTERIOR WALL SYSTEM – STAGGERED STUD



**STAGGERED STEEL STUDS AT 600mm MAX CENTRES**

Side 1 1 x 9mm BGC Duraliner™ Plus  
 Side 2 1 x 16mm GTEK™ Fire

**GTEK-SS036**

FRL	CAVITY WIDTH mm	76	92	150
	CAVITY INFILL	Rw/Rw+Ctr		
-/-/-	Nil	39/31	39/32	41/33
	9kg - 50mm Glasswool	48/37	49/37	52/42
	30kg - 75mm Glasswool	49/38	50/38	53/43
	<b>WALL THICKNESS mm</b>	<b>101</b>	<b>117</b>	<b>175</b>



**STAGGERED STEEL STUDS AT 600mm MAX CENTRES**

Side 1 1 x 16mm GTEK™ Fire (against studs)  
 1 x 9mm BGC Duraliner™ Plus  
 Side 2 1 x 16mm GTEK™ Fire (against studs)  
 1 x 9mm BGC Duraliner™ Plus

**GTEK-SS041**

FRL	CAVITY WIDTH mm	76	92	150
	CAVITY INFILL	Rw/Rw+Ctr		
-/60/60 60/60/60	Nil	47/39	48/40	51/43
	9kg - 50mm Glasswool	57/47	58/49	60/52
	30kg - 75mm Glasswool	58/48	59/50	61/53
	<b>WALL THICKNESS mm</b>	<b>98</b>	<b>114</b>	<b>172</b>



**STAGGERED STEEL STUDS AT 600mm MAX CENTRES**

Side 1 1 x 13mm GTEK™ Fire (against studs)  
 1 x 6mm Duraliner™ Plus  
 Side 2 1 x 13mm GTEK™ Fire (against studs)  
 1 x 6mm Duraliner™ Plus

Please refer to p54 for fixing

**GTEK-SS042**

FRL	CAVITY WIDTH mm	76	92	150
	CAVITY INFILL	Rw/Rw+Ctr		
-/60/60	Nil	46/39	47/39	49/41
	9kg - 50mm Glasswool	58/48	60/49	62/53
	30kg - 75mm Glasswool	58/48	60/49	62/53
	<b>WALL THICKNESS mm</b>	<b>98</b>	<b>114</b>	<b>172</b>

STEEL FRAME INTERIOR WALL SYSTEM – STAGGERED STUD



**STAGGERED STEEL STUDS AT 600mm MAX CENTRES**

- Side 1 1 x 9mm BGC Duraliner™ Plus (against studs)  
1 x 16mm GTEK™ Fire
- Side 2 1 x 9mm BGC Duraliner™ Plus (against studs)  
1 x 16mm GTEK™ Fire

Previously BGC DL001

**GTEK-SS043**

FRL	CAVITY WIDTH mm	76	92	150
	CAVITY INFILL	Rw/Rw+Ctr		
-/120/120	Nil	47/39	48/40	51/43
	9kg - 50mm Glasswool	57/47	58/49	60/52
	30kg - 75mm Glasswool	58/48	59/50	61/53
	WALL THICKNESS mm	98	114	172

STEEL FRAME INTERIOR WALL SYSTEM – DOUBLE STUD



MIN 20mm GAP BETWEEN STUD WALLS  
 2 ROWS OF STEEL STUDS AT 600mm MAX CENTRES  
 Side 1 1 x 10mm GTEK™ Wall  
 Side 2 1 x 10mm GTEK™ Wall

GTEK-SD001

FRL	CAVITY WIDTH mm	148	172	204	320
	CAVITY INFILL	Rw/Rw+Ctr			
-/-/-	Nil	34/28	34/28	35/28	36/28
	9kg - 50mm Glasswool - 1 side	44/33	45/35	46/37	46/39
	9kg - 50mm Glasswool - 2 sides	46/35	47/37	48/39	48/41
	30kg - 75mm Glasswool - 1 side	47/36	49/38	49/40	49/41
	30kg - 75mm Glasswool - 2 sides	49/36	49/38	49/39	50/42
	WALL THICKNESS mm	168	192	224	340



MIN 20mm GAP BETWEEN STUD WALLS  
 2 ROWS OF STEEL STUDS AT 600mm MAX CENTRES  
 Side 1 1 x 13mm GTEK™ Wall  
 Side 2 1 x 13mm GTEK™ Wall

GTEK-SD002

FRL	CAVITY WIDTH mm	148	172	204	320
	CAVITY INFILL	Rw/Rw+Ctr			
-/-/-	Nil	39/33	39/32	40/33	42/34
	9kg - 50mm Glasswool - 1 side	51/42	52/43	52/44	52/46
	9kg - 50mm Glasswool - 2 sides	53/43	54/44	54/46	55/48
	30kg - 75mm Glasswool - 1 side	54/43	54/44	55/46	56/48
	30kg - 75mm Glasswool - 2 sides	56/45	57/45	57/47	58/49
	WALL THICKNESS mm	174	198	230	346



MIN 20mm GAP BETWEEN STUD WALLS  
 2 ROWS OF STEEL STUDS AT 600mm MAX CENTRES  
 Side 1 1 x 10mm GTEK™ Sound  
 Side 2 1 x 10mm GTEK™ Sound

GTEK-SD006

FRL	CAVITY WIDTH mm	148	172	204	320
	CAVITY INFILL	Rw/Rw+Ctr			
-/-/-	Nil	39/32	39/33	40/33	42/33
	9kg - 50mm Glasswool - 1 side	51/41	52/43	52/44	52/46
	9kg - 50mm Glasswool - 2 sides	53/43	54/45	55/46	55/49
	30kg - 75mm Glasswool - 1 side	54/43	55/45	56/46	56/49
	30kg - 75mm Glasswool - 2 sides	56/44	57/46	57/47	58/49
	WALL THICKNESS mm	168	192	224	340

STEEL FRAME INTERIOR WALL SYSTEM – DOUBLE STUD



MIN 20mm GAP BETWEEN STUD WALLS  
 2 ROWS OF STEEL STUDS AT 600mm MAX CENTRES  
 Side 1 1 x 13mm GTEK™ Sound  
 Side 2 1 x 13mm GTEK™ Sound

GTEK-SD007

FRL	CAVITY WIDTH mm	148	172	204	320
	CAVITY INFILL	Rw/Rw+Ctr			
-/-/-	Nil	42/35	42/35	43/36	46/37
	9kg - 50mm Glasswool - 1 side	54/45	55/47	55/48	56/49
	9kg - 50mm Glasswool - 2 sides	56/45	57/48	57/49	58/49
	30kg - 75mm Glasswool - 1 side	57/46	57/48	58/49	59/50
	30kg - 75mm Glasswool - 2 sides	59/48	60/49	60/49	61/50
	WALL THICKNESS mm	174	198	230	346



MIN 20mm GAP BETWEEN STUD WALLS  
 2 ROWS OF STEEL STUDS AT 600mm MAX CENTRES  
 Side 1 1 x 13mm GTEK™ Fire  
 Side 2 1 x 13mm GTEK™ Fire

GTEK-SD011

FRL	CAVITY WIDTH mm	148	172	204	320
	CAVITY INFILL	Rw/Rw+Ctr			
-/60/60	Nil	40/34	41/34	42/35	43/35
	9kg - 50mm Glasswool - 1 side	52/43	52/45	53/45	53/48
	9kg - 50mm Glasswool - 2 sides	54/45	54/46	55/47	55/49
	30kg - 75mm Glasswool - 1 side	55/46	56/47	57/48	57/49
	30kg - 75mm Glasswool - 2 sides	57/46	58/47	58/48	59/49
	WALL THICKNESS mm	174	198	230	346



MIN 20mm GAP BETWEEN STUD WALLS  
 2 ROWS OF STEEL STUDS AT 600mm MAX CENTRES  
 Side 1 1 x 16mm GTEK™ Fire (against studs)  
 1 x 10mm GTEK™ Wall  
 Side 2 1 x 16mm GTEK™ Fire (against studs)  
 1 x 10mm GTEK™ Wall

GTEK-SD016

FRL	CAVITY WIDTH mm	148	172	204	320
	CAVITY INFILL	Rw/Rw+Ctr			
-/60/60 60/60/60	Nil	46/39	47/39	48/39	49/40
	9kg - 50mm Glasswool - 1 side	58/48	59/49	59/49	59/50
	9kg - 50mm Glasswool - 2 sides	60/51	61/52	61/53	62/53
	30kg - 75mm Glasswool - 1 side	61/51	62/52	62/53	63/54
	30kg - 75mm Glasswool - 2 sides	63/52	65/53	65/54	66/55
	WALL THICKNESS mm	200	224	256	372

STEEL FRAME INTERIOR WALL SYSTEM – DOUBLE STUD



MIN 20mm GAP BETWEEN STUD WALLS  
 2 ROWS OF STEEL STUDS AT 600mm MAX CENTRES  
 Side 1 1 x 16mm GTEK™ Fire  
 Side 2 1 x 16mm GTEK™ Fire

GTEK-SD019

FRL	CAVITY WIDTH mm	148	172	204	320
	CAVITY INFILL	Rw/Rw+Ctr			
-/60/60 60/60/60	Nil	41/34	41/34	42/35	45/36
	9kg - 50mm Glasswool - 1 side	53/45	54/46	54/47	55/49
	9kg - 50mm Glasswool - 2 sides	55/46	56/45	56/49	57/51
	14kg - 75mm Glasswool - 1 side	56/46	56/47	57/49	58/51
	14kg - 75mm Glasswool - 2 sides	58/48	59/49	60/50	61/52
	WALL THICKNESS mm	180	204	236	352



MIN 20mm GAP BETWEEN STUD WALLS  
 2 ROWS OF STEEL STUDS AT 600mm MAX CENTRES  
 Side 1 2 x 13mm GTEK™ Fire  
 Side 2 2 x 13mm GTEK™ Fire

GTEK-SD021

FRL	CAVITY WIDTH mm	148	172	204	320
	CAVITY INFILL	Rw/Rw+Ctr			
-/120/120 90/90/90	Nil	48/40	49/41	50/41	53/44
	9kg - 50mm Glasswool - 1 side	60/51	60/52	61/53	61/55
	9kg - 50mm Glasswool - 2 sides	62/52	62/53	63/55	63/57
	30kg - 75mm Glasswool - 1 side	63/53	64/54	65/56	65/58
	30kg - 75mm Glasswool - 2 sides	65/58	66/58	67/58	68/60
	WALL THICKNESS mm	200	224	256	372



MIN 20mm GAP BETWEEN STUD WALLS  
 2 ROWS OF STEEL STUDS AT 600mm MAX CENTRES  
 Side 1 2 x 16mm GTEK™ Fire  
 Side 2 2 x 16mm GTEK™ Fire

GTEK-SD023

FRL	CAVITY WIDTH mm	148	172	204	320
	CAVITY INFILL	Rw/Rw+Ctr			
-/120/120 120/120/120	Nil	48/40	49/41	51/42	54/44
	9kg - 50mm Glasswool - 1 side	60/52	61/53	61/54	62/56
	9kg - 50mm Glasswool - 2 sides	62/53	63/54	63/55	64/58
	30kg - 75mm Glasswool - 1 side	63/53	64/54	64/56	65/58
	30kg - 75mm Glasswool - 2 sides	65/58	66/58	66/58	67/60
	WALL THICKNESS mm	212	236	268	384

STEEL FRAME INTERIOR WALL SYSTEM – DOUBLE STUD



MIN 20mm GAP BETWEEN STUD WALLS  
 2 ROWS OF STEEL STUDS AT 600mm MAX CENTRES  
 Side 1 2 x 13mm GTEK™ Fire  
 Side 2 1 x 13mm GTEK™ Fire

GTEK-SD024

FRL	CAVITY WIDTH mm	148	172	204	320
	CAVITY INFILL	Rw/Rw+Ctr			
-/60/60	Nil	45/38	46/39	47/39	49/40
	9kg - 50mm Glasswool - 1 side	57/48	57/49	58/49	59/50
	9kg - 50mm Glasswool - 2 sides	59/50	59/51	60/52	61/53
	30kg - 75mm Glasswool - 1 side	60/50	61/51	62/53	63/54
	30kg - 75mm Glasswool - 2 sides	62/54	63/54	64/54	65/55
	WALL THICKNESS mm	187	211	243	359



MIN 20mm GAP BETWEEN STUD WALLS  
 2 ROWS OF STEEL STUDS AT 600mm MAX CENTRES  
 Side 1 3 x 13mm GTEK™ Fire  
 Side 2 3 x 13mm GTEK™ Fire

GTEK-SD025

FRL	CAVITY WIDTH mm	148	172	204	320
	CAVITY INFILL	Rw/Rw+Ctr			
-/120/120 90/90/90	Nil	54/45	55/46	56/47	59/49
	9kg - 50mm Glasswool - 1 side	67/58	67/59	68/60	68/62
	9kg - 50mm Glasswool - 2 sides	68/58	68/59	69/61	69/63
	30kg - 75mm Glasswool - 1 side	69/58	69/60	70/61	71/64
	30kg - 75mm Glasswool - 2 sides	71/59	71/60	72/62	73/65
	WALL THICKNESS mm	226	250	282	398



MIN 20mm GAP BETWEEN STUD WALLS  
 2 ROWS OF STEEL STUDS AT 600mm MAX CENTRES  
 Side 1 3 x 16mm GTEK™ Fire  
 Side 2 3 x 16mm GTEK™ Fire

GTEK-SD026

FRL	CAVITY WIDTH mm	148	172	204	320
	CAVITY INFILL	Rw/Rw+Ctr			
-/180/180 120/120/120	Nil	55/46	56/46	57/47	60/49
	9kg - 50mm Glasswool - 1 side	67/59	68/60	68/61	69/63
	9kg - 50mm Glasswool - 2 sides	69/60	70/61	70/63	71/65
	30kg - 75mm Glasswool - 1 side	70/60	71/61	71/63	72/65
	30kg - 75mm Glasswool - 2 sides	72/61	73/62	73/63	74/67
	WALL THICKNESS mm	244	268	300	416



STEEL FRAME INTERIOR WALL SYSTEM – DOUBLE STUD



MIN 20mm GAP BETWEEN STUD WALLS  
 2 ROWS OF STEEL STUDS AT 600mm MAX CENTRES  
 Side 1 1 x 6mm BGC Duraliner™ Plus  
 Side 2 1 x 6mm BGC Duraliner™ Plus

GTEK-SD027

FRL	CAVITY WIDTH mm	148	172	204	320
	CAVITY INFILL	Rw/Rw+Ctr			
-/-/-	Nil	38/31	39/32	39/32	41/33
	9kg - 50mm Glasswool - 1 side	50/40	51/41	51/43	52/45
	9kg - 50mm Glasswool - 2 sides	52/41	53/43	53/44	54/46
	30kg - 75mm Glasswool - 1 side	53/42	54/43	54/45	55/47
	30kg - 75mm Glasswool - 2 sides	55/43	57/45	57/47	58/49
	WALL THICKNESS mm	160	184	216	332



MIN 20mm GAP BETWEEN STUD WALLS  
 2 ROWS OF STEEL STUDS AT 600mm MAX CENTRES  
 Side 1 1 x 9mm BGC Duraliner™ Plus  
 Side 2 1 x 9mm BGC Duraliner™ Plus

GTEK-SD028

FRL	CAVITY WIDTH mm	148	172	204	320
	CAVITY INFILL	Rw/Rw+Ctr			
-/-/-	Nil	42/35	43/35	44/36	46/38
	9kg - 50mm Glasswool - 1 side	54/44	55/45	55/47	56/49
	9kg - 50mm Glasswool - 2 sides	56/46	57/47	57/48	58/49
	30kg - 75mm Glasswool - 1 side	57/46	58/48	58/49	59/49
	30kg - 75mm Glasswool - 2 sides	59/48	60/49	60/49	62/50
	WALL THICKNESS mm	166	190	222	338



MIN 20mm GAP BETWEEN STUD WALLS  
 2 ROWS OF STEEL STUDS AT 600mm MAX CENTRES  
 Side 1 1 x 13mm GTEK™ Fire (against studs)  
 1 x 6mm Duraliner™ Plus  
 Side 2 1 x 13mm GTEK™ Fire (against studs)  
 1 x 6mm Duraliner™ Plus

GTEK-SD038

FRL	CAVITY WIDTH mm	148	172	204	320
	CAVITY INFILL	Rw/Rw+Ctr			
-/60/60	Nil	46/38	46/38	48/39	49/39
	9kg - 50mm Glasswool - 1 side	58/48	58/49	59/49	59/50
	9kg - 50mm Glasswool - 2 sides	60/50	61/51	62/52	62/53
	30kg - 75mm Glasswool - 1 side	61/50	62/51	63/53	64/54
	30kg - 75mm Glasswool - 2 sides	63/52	64/52	65/53	66/55
	WALL THICKNESS mm	186	210	242	358

STEEL FRAME INTERIOR WALL SYSTEM – DOUBLE STUD



**MIN 20mm GAP BETWEEN STUD WALLS  
2 ROWS OF STEEL STUDS AT 600mm MAX CENTRES**

- Side 1 1 x 6mm Duraliner™ Plus (against studs)  
1 x 16mm GTEK™ Fire
- Side 2 1 x 6mm Duraliner™ Plus (against studs)  
1 x 16mm GTEK™ Fire

**GTEK-SD042**

FRL	CAVITY WIDTH mm	148	172	204	320
	CAVITY INFILL	Rw/Rw+Ctr			
-/60/60 60/60/60	Nil	48/40	49/40	50/41	51/42
	9kg - 50mm Glasswool - 1 side	60/51	60/52	61/53	61/55
	9kg - 50mm Glasswool - 2 sides	62/52	62/53	63/54	63/57
	30kg - 75mm Glasswool - 1 side	63/53	64/54	65/55	65/58
	30kg - 75mm Glasswool - 2 sides	65/56	66/56	66/56	67/59
	<b>WALL THICKNESS mm</b>	<b>192</b>	<b>216</b>	<b>248</b>	<b>364</b>



**MIN 20mm GAP BETWEEN STUD WALLS  
2 ROWS OF STEEL STUDS AT 600mm MAX CENTRES**

- Side 1 1 x 9mm Duraliner™ Plus (against studs)  
1 x 16mm GTEK™ Fire
- Side 2 1 x 9mm Duraliner™ Plus (against studs)  
1 x 16mm GTEK™ Fire

Previously BGC DL001

**GTEK-SD043**

FRL	CAVITY WIDTH mm	148	172	204	320
	CAVITY INFILL	Rw/Rw+Ctr			
-/120/120	Nil	48/39	49/40	50/41	53/43
	9kg - 50mm Glasswool - 1 side	60/51	61/52	61/53	61/55
	9kg - 50mm Glasswool - 2 sides	62/52	63/53	63/55	64/57
	30kg - 75mm Glasswool - 1 side	63/52	63/53	64/55	65/58
	30kg - 75mm Glasswool - 2 sides	65/54	66/55	67/57	68/60
	<b>WALL THICKNESS mm</b>	<b>198</b>	<b>222</b>	<b>254</b>	<b>370</b>

STEEL FRAME INTERIOR WALL SYSTEM – DOUBLE STUD



MIN 20mm GAP BETWEEN STUD WALLS  
 2 ROWS OF STEEL STUDS AT 600mm MAX CENTRES  
 Side 1 2 x 13mm GTEK™ Total Plus  
 Side 2 2 x 13mm GTEK™ Total Plus

GTEK-E5SD001

FRL	CAVITY WIDTH mm	148	172	204	320
	CAVITY INFILL	Rw/Rw+Ctr			
-/120/120 90/90/90	Nil	48/40	49/41	50/41	53/43
	9kg - 50mm Glasswool - 1side	60/52	61/53	61/54	62/56
	9kg - 50mm Glasswool - 2 sides	61/52	62/53	52/54	53/56
	11kg - 75mm Glasswool 1 side	60/52	61/53	61/54	62/56
	11kg - 75mm Glasswool 2 sides	61/52	62/53	62/54	63/56
	30kg - 75mm Glasswool - 1 side	61/52	62/53	62/54	63/56
	30kg - 75mm Glasswool - 2 sides	63/56	64/57	64/57	65/58
	<b>WALL THICKNESS mm</b>	<b>198</b>	<b>222</b>	<b>254</b>	<b>370</b>

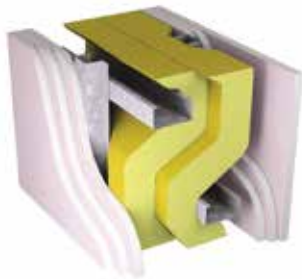
GTEK™ CINEMA WALL SYSTEM

**SYSTEM SET OUT**

- ▶ Top hat sections (50mm x 35mm x 1.15m) fixed vertically at 900mm max centres to engineers design and supported at the head and the base with tracks
- ▶ The span of the Top hats between girts shall be nominally 1.9m for single spans and 2.7m for continuous spans. To be confirmed as suitable by the engineer for internal wind pressures.
- ▶ Steel columns and girts to be engineer specified
- ▶ Girts to be fixed to vertical steel columns using proprietary isolation mounts that include a through bolt

**PLASTERBOARD FIXINGS**

- ▶ Layer 1 to Top hat – 30mm bugle head screws at 600mm centres
- ▶ Layer 2 to Top hat – 45mm bugle head screws at 300mm centres and laminating screws at 300mm centres 200mm from top and bottom
- ▶ Layer 3 to layer 2 – 38mm laminating screws at 400mm x 400mm grid
- ▶ Layer 4 to layer 3 – 38mm laminating screws at 400mm x 400mm grid
- ▶ 2 layers glasswool insulation. Refer to insulation in system specification
- ▶ Perimeters to be caulked with fire rated caulking to a depth of 30mm x 10mm wide when used with a backing rod
- ▶ Vertical control joints to be caulked to a depth of 16mm backed with plaster



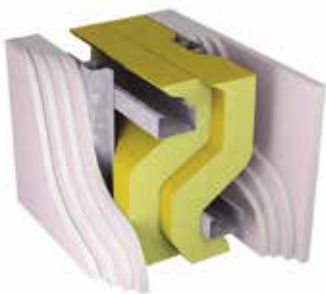
**STEEL TOP HATS AT 900mm MAX CENTRES**

Side 1 3 x 16mm GTEK™ Fire

Side 2 3 x 16mm GTEK™ Fire

**GTEK-SC001**

FRL	STUD DEPTH mm	375
	CAVITY INFILL	Rw/Rw+Ctr
90/90/90	Nil	75/68
	9kg - 50mm Glasswool	75/68
	30kg - 75mm Glasswool	74/67
	WALL THICKNESS mm	471



**STEEL TOP HATS AT 900mm MAX CENTRES**

Side 1 4 x 16mm GTEK™ Fire

Side 2 4 x 16mm GTEK™ Fire

**GTEK-SC002**

FRL	STUD DEPTH mm	375
	CAVITY INFILL	Rw/Rw+Ctr
120/120/120	Nil	79/72
	9kg - 50mm Glasswool	79/72
	30kg - 75mm Glasswool	78/71
	WALL THICKNESS mm	503

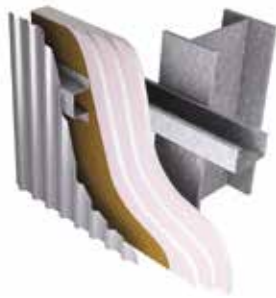
COMMERCIAL EXTERIOR WALL

SYSTEM SET OUT

- ▶ Girts shall be sized to meet relevant structural standards
- ▶ BMT shall not exceed 2.0mm
- ▶ Installed horizontally at max 1200mm centres and screw fixed into position by using 14-10 x 25mm Hex Head Self Drilling screws
- ▶ Wall columns should be designed to meet structural codes and span and size may vary
- ▶ Perimeter angles 50mm x 50mm x 0.75 BMT and installed along the perimeter of the plasterboard using M6.5 x 35mm long sleeve anchors at 600mm centres
- ▶ Top Hat sections to be min 0.42 min thick and 35mm deep installed horizontally and screw fixed to girts through the 3 layers of plasterboard using plasterboard fixings at 1200mm centres
- ▶ Building paper spaced 600mm centres
- ▶ Bostik Fireban One polyurethane sealant
- ▶ Steel Wall track

PLASTERBOARD FIXINGS

- ▶ Layer 1 - 6g x 30mm bugle head self drilling screws at 200mm centres around the perimeter and at 200mm staggered centres along horizontal butt join. Nominally 15mm from edges and at 300mm centres in the field where overlapping girts
- ▶ Layer 2 - 6g x 45mm bugle head self drilling screws and 10g x 38mm laminating screws. Fixed to 1st layer using laminating screws at 200mm centres along vertical recessed joints, 200mm centres staggered along horizontal butt join and 400mm x 400mm grids in centres. 45mm screws used around perimeter into metal angles at 200mm centres
- ▶ Layer 3 - 10g x 38mm laminating screws. Fixed to 1st and 2nd layers at 200mm centres along vertical recess joints, 200mm staggered along horizontal butt join and 400mm x 400mm grids in the field of the plasterboard and 200mm centres at the edges



STRUCTURAL STEEL GIRTS TO ENGINEERS DETAIL

Side 1  
Side 2 3 x 13mm GTEK™ Fire

GTEK-SCE001

FRL	GIRT SPACING mm	1200
	CAVITY INFILL	Rw/Rw+Ctr
90/90/90	Nil	41/35
	WALL THICKNESS mm	91

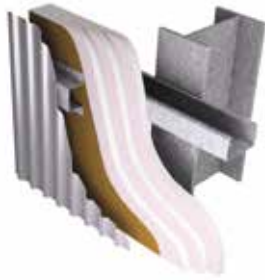
COMMERCIAL EXTERIOR WALL

SYSTEM SET OUT

- ▶ Girts shall 65mm x 150mm with 15mm lip x 2.0mm BMT
- ▶ Installed horizontally at max 1200mm centres and screw fixed into position by using 14-10 x 25mm Hex Head Self Drilling screws
- ▶ The bottom girt is installed at a height of 250mm from base
- ▶ Wall posts should be designed to meet structural codes and span and size may vary
- ▶ Perimeter angles 50mm x 50mm x 0.75 BMT and installed along the perimeter of the plasterboard using M6.5 x 35mm long sleeve anchors at 600mm centres
- ▶ Top Hat sections to be min 0.42 min thick and 35mm deep installed horizontally and screw fixed to girts through the 3 layers of plasterboard using plasterboard fixings at 1200mm centres
- ▶ Building paper spaced 600mm centres
- ▶ Bostik Fireban One polyurethane sealant
- ▶ Steel Wall track

PLASTERBOARD FIXINGS

- ▶ Layer 1 - 6g x 30mm bugle head self drilling screws at 200mm centres around the perimeter and at 200mm staggered centres along horizontal butt joint. Nominally 15mm from edges
- ▶ Layer 2 - 6g x 45mm bugle head self drilling screws and 10g x 38mm laminating screws. Fixed to 1st layer using laminating screws at 200mm centres along vertical recessed joints, 200mm centres staggered along horizontal butt joint and 400mm x 400mm grids in centres. 45mm screws used around perimeter into metal angles at 200mm centres and at 300mm centres in the field where overlapping the girts
- ▶ Layer 3 - 10g x 38mm laminating screws. Fixed to 1st and 2nd layers at 200mm centres along vertical recess joints, 200mm staggered along horizontal butt joint and 400mm x 400mm grids in the field of the plasterboard and 200mm centres at the edges



STRUCTURAL STEEL GIRTS TO ENGINEERS DETAIL

Side 1  
Side 2 3 x 16 mm GTEK™ Fire

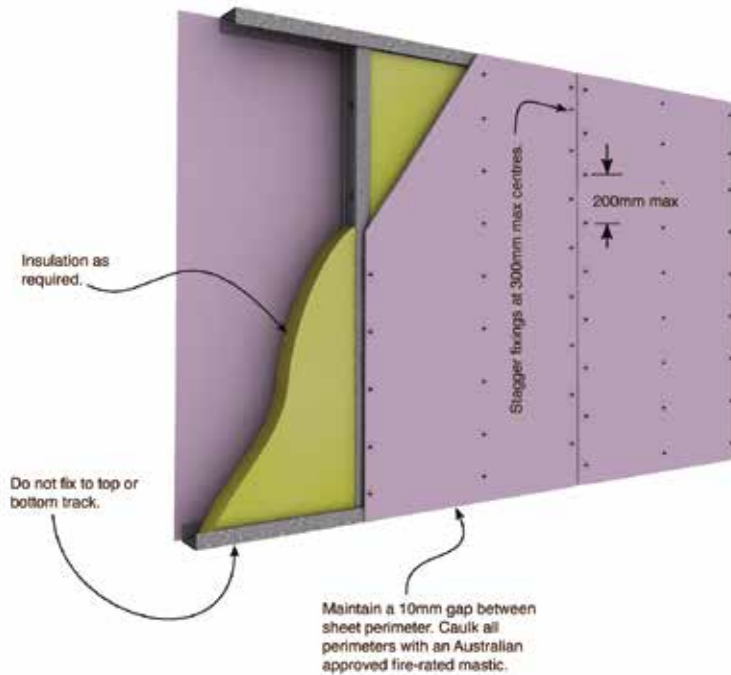
GTEK-SCE002

FRL	GIRT SPACING mm	1200
	CAVITY INFILL	Rw/Rw+Ctr
90/90/90	Nil	42/36
	WALL THICKNESS mm	100



INSTALLATION DETAILS - STEEL STUD

STEEL FRAME WITH ONE LAYER GTEK™ FIRE - VERTICAL SHEETING

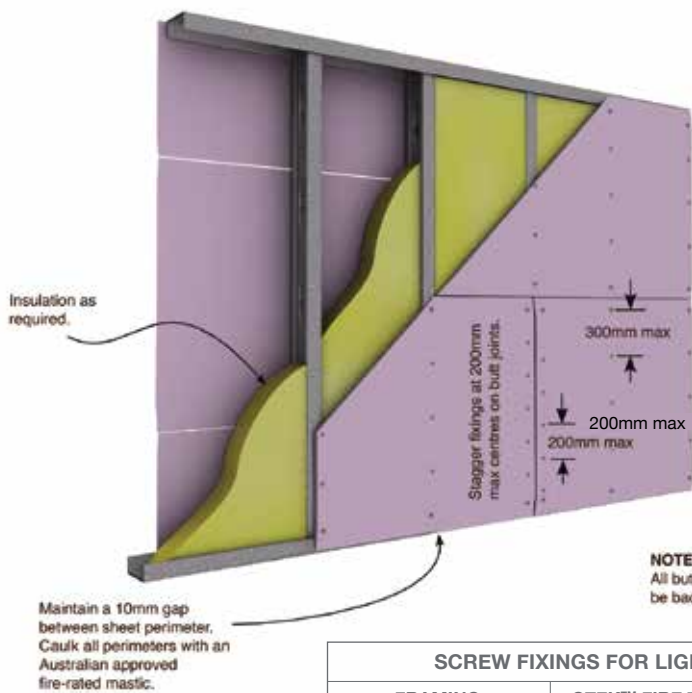


- NOTE:** Final layer needs to be flushed and jointed.
- NOTE:** Fasteners 10-16mm from the edge unless otherwise noted.
- NOTE:** Load-bearing. Fasten top and bottom track at 200mm centres.
- NOTE:** All butt joints must be backed by studs.

FIXING SPECIFICATIONS	
FASTENER SPACING	POSITION
300mm max. centres	Centre of the Board
200mm max. centres	Recessed Edges
200mm max. centres	Stagger Butt Joints
200mm max. centres	Corners & Openings

SCREW FIXINGS FOR LIGHTWEIGHT STEEL FRAMING			SCREW LENGTH
FRAMING	GTEK™ FIRE THICKNESS	SCREW TYPE	1ST LAYER
Lightweight Steel up to 0.8mm	13mm	No 6 Type S Needle Point	25mm
	16mm	No 6 Type S Needle Point	30mm
Lightweight Steel 0.8mm to 1.6mm	13mm	No 6 Type D Drill Point	32mm
	16mm	No 6 Type D Drill Point	32mm

STEEL FRAME WITH ONE LAYER GTEK™ FIRE - HORIZONTAL SHEETING



- NOTE:** Final layer needs to be flushed and jointed.
- NOTE:** Fasteners 10-16mm from the edge unless otherwise noted.
- NOTE:** Recessed joints to be offset a minimum 300mm in opposing sides when not backed by a noggin.
- NOTE:** Load Bearing. Fasten to top and bottom track at 200mm centres.

**NOTE:** All butt joints must be backed by studs.

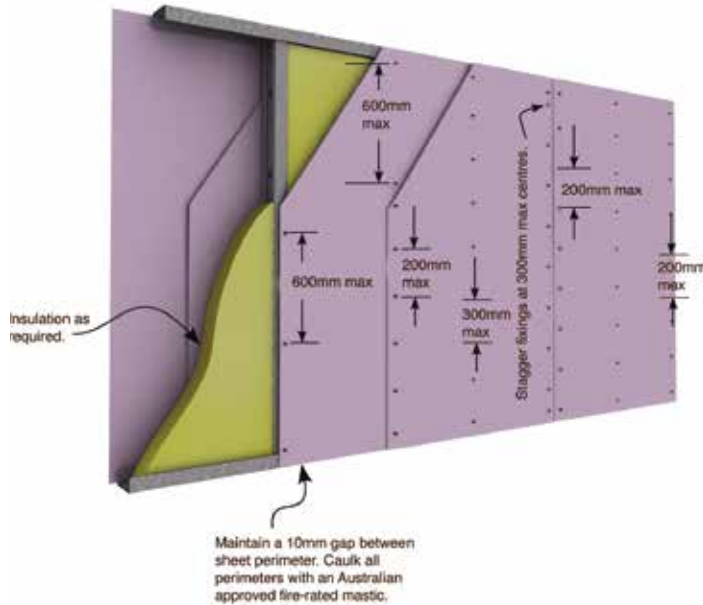
FIXING SPECIFICATIONS	
FASTENER SPACING	POSITION
300mm max. centres	Centre of the Board
At each stud	Recessed Edges
200mm max. centres	Butt Joints
200mm max. centres	Corners, Openings & Edges

SCREW FIXINGS FOR LIGHTWEIGHT STEEL FRAMING			SCREW LENGTH
FRAMING	GTEK™ FIRE THICKNESS	SCREW TYPE	1ST LAYER
Lightweight Steel up to 0.8mm	13mm	No 6 Type S Needle Point	25mm
	16mm	No 6 Type S Needle Point	30mm
Lightweight Steel 0.8mm to 1.6mm	13mm	No 6 Type D Drill Point	32mm
	16mm	No 6 Type D Drill Point	32mm



INSTALLATION DETAILS - STEEL STUD

STEEL FRAME WITH TWO LAYERS GTEK™ FIRE - VERTICAL SHEETING



**NOTE:**  
Final layer needs to be flushed and jointed.

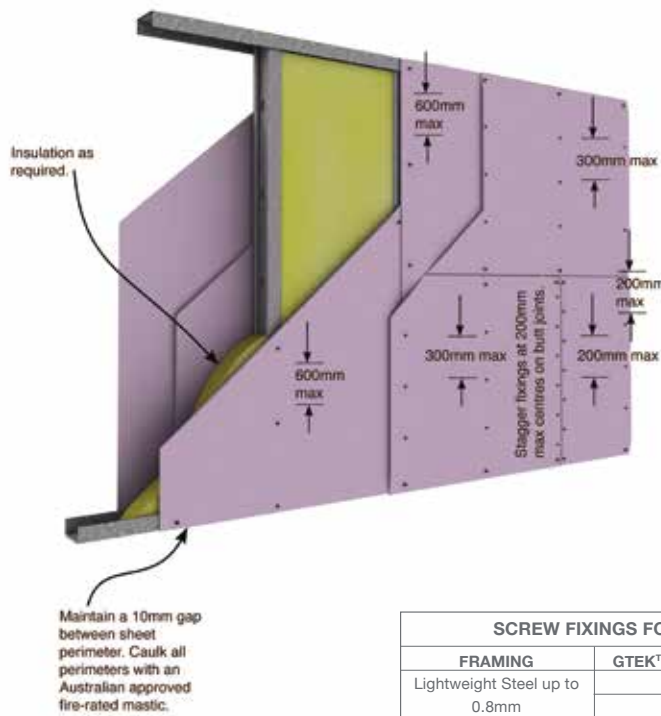
**NOTE:**  
Fasteners 10-16mm from the edge unless otherwise noted.

**NOTE:**  
Load Bearing. Fasten to top and bottom track at 200mm centres.

FIXING SPECIFICATIONS FIRST LAYER	
FASTENER SPACING	LOCATION
600mm max. centres	Centre of the Board
600mm max. centres	Recessed Edges
600mm max. centres	Corners & Openings
SECOND LAYER	
300mm max. centres	Centre of the Board
200mm max. centres	Recessed Edges Staggered
200mm max. centres	Butt Joints Staggered
200mm max. centres	Corners & Openings

SCREW FIXINGS FOR LIGHTWEIGHT STEEL FRAMING			SCREW LENGTH	
FRAMING	GTEK™ FIRE THICKNESS	SCREW TYPE	1ST LAYER	2ND LAYER
Lightweight Steel up to 0.8mm	13mm	No 6 Type S Needle Point	25mm	45mm
	16mm	No 6 Type S Needle Point	30mm	45mm
Lightweight Steel 0.8mm to 1.6mm	13mm	No 6 Type D Drill Point	32mm	45mm
	16mm	No 6 Type D Drill Point	32mm	45mm

STEEL FRAME WITH TWO LAYERS GTEK™ FIRE - FIRST LAYER VERTICAL, SECOND LAYER HORIZONTAL



**NOTE:**  
Final layer needs to be flushed and jointed.

**NOTE:**  
Fasteners 10-16mm from the edge unless otherwise noted.

**NOTE:**  
Load Bearing. Fasten to top and bottom track at 200mm centres.

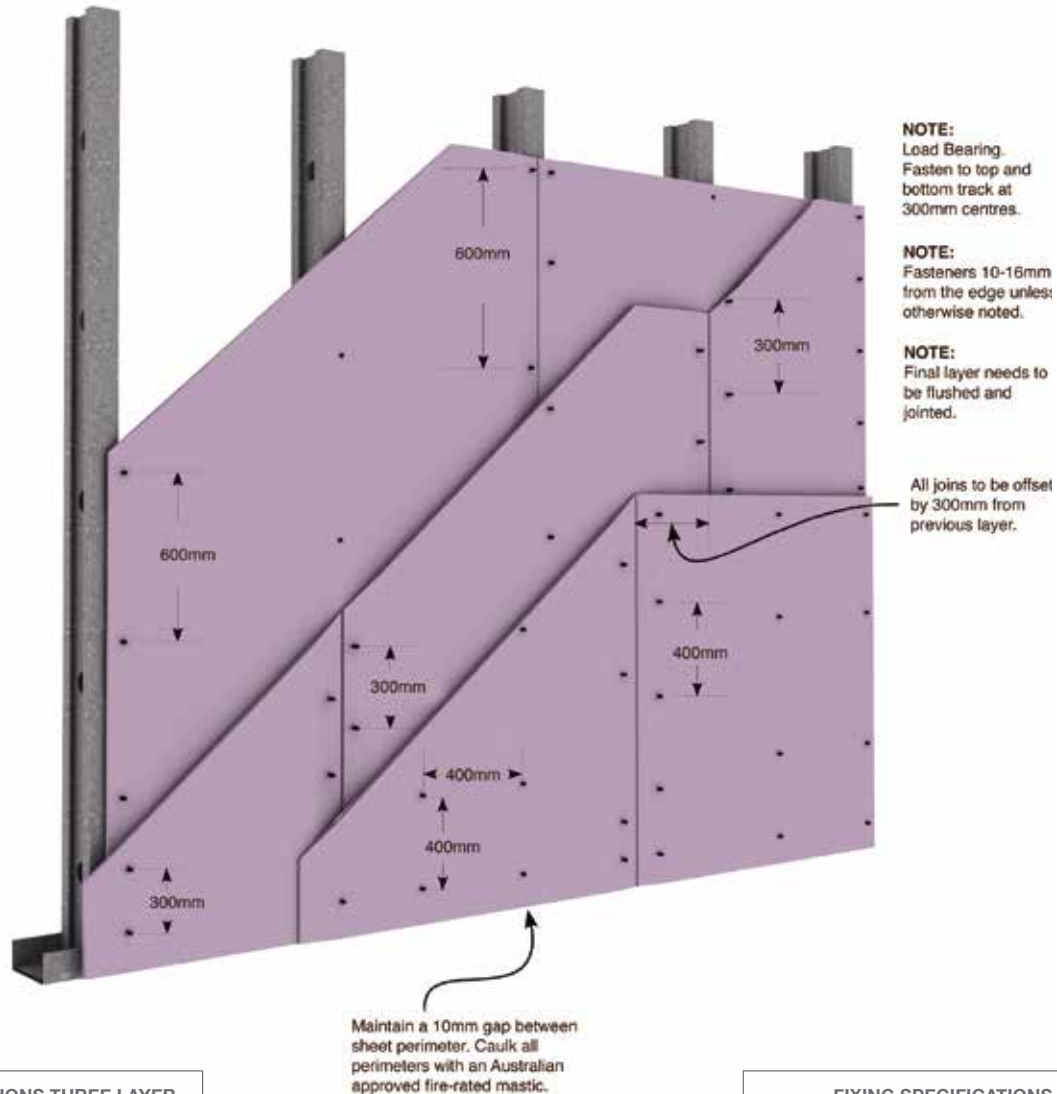
**NOTE:**  
Butt/Recessed joints to be offset a minimum 300mm in opposing sides when not backed by a noggin.

FIXING SPECIFICATIONS FIRST LAYER	
FASTENER SPACING	LOCATION
600mm max. centres	Centre of the Board
600mm max. centres	Recessed Edges
600mm max. centres	Corners & Openings
SECOND LAYER	
300mm max. centres	Centre of the Board
At Each Stud	Recessed Edges
200mm max. centres	Butt Joints Staggered
200mm max. centres	Corners & Openings

SCREW FIXINGS FOR LIGHTWEIGHT STEEL FRAMING			SCREW LENGTH	
FRAMING	GTEK™ FIRE THICKNESS	SCREW TYPE	1ST LAYER	2ND LAYER
Lightweight Steel up to 0.8mm	13mm	No 6 Type S Needle Point	25mm	45mm
	16mm	No 6 Type S Needle Point	30mm	45mm
Lightweight Steel 0.8mm to 1.6mm	13mm	No 6 Type D Drill Point	32mm	45mm
	16mm	No 6 Type D Drill Point	32mm	45mm

INSTALLATION DETAILS - STEEL STUD

STEEL FRAME WITH THREE LAYERS GTEK™ FIRE - VERTICAL SHEETING



- NOTE:** Load Bearing. Fasten to top and bottom track at 300mm centres.
- NOTE:** Fasteners 10-16mm from the edge unless otherwise noted.
- NOTE:** Final layer needs to be flushed and jointed.

All joints to be offset by 300mm from previous layer.

Maintain a 10mm gap between sheet perimeter. Caulk all perimeters with an Australian approved fire-rated mastic.

**FIXING SPECIFICATIONS THREE LAYER VERTICAL (Shown) FIRST LAYER**

FASTENER SPACING	LOCATION
600mm max. centres	Centre of the Board
600mm max. centres	Recessed Edges
600mm max. centres	Corners & Openings

**SECOND LAYER**

300mm max. centres	Centre of the Board
300mm max. centres	Recessed Edges
200mm max. centres	Butt Joints Staggered
300mm max. centres	Corners & Openings

**THIRD LAYER**

Laminating Screws at 400mm max. grid	Centre of the Board
	Recessed Edges
	Butt Joints
	Corners & Openings

**FIXING SPECIFICATIONS THREE LAYER HORIZONTAL FIRST LAYER**

FASTENER SPACING	LOCATION
600mm max. centres	Centre of the Board
600mm max. centres	Recessed Edges
600mm max. centres	Corners, Openings & Edges

**SECOND LAYER**

300mm max. centres	Centre of the Board
600mm max. centres	Recessed Edges
200mm max. centres	Butt Joints Staggered
300mm max. centres	Corners, Openings & Edges

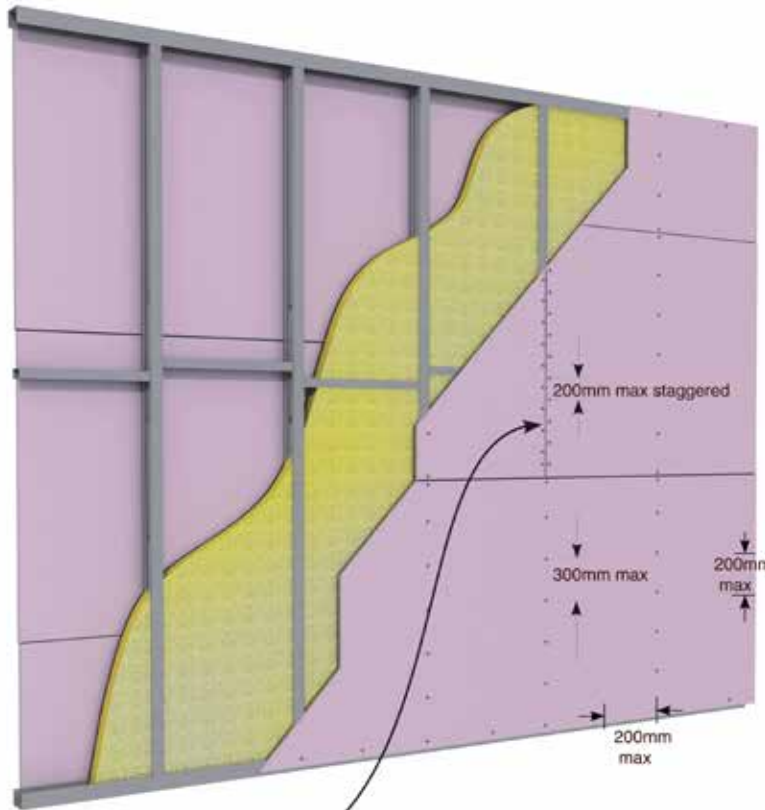
**THIRD LAYER**

Laminating Screws at 400mm max. grid	Centre of the Board
	Recessed Edges
	Butt Joints
	Corners, Openings & Edges

SCREW FIXINGS FOR LIGHTWEIGHT STEEL FRAMING			SCREW LENGTH	
FRAMING	GTEK™ FIRE THICKNESS	SCREW TYPE	1ST LAYER	2ND LAYER
Lightweight Steel up to 0.8mm	13mm	No 6 Type S Needle Point	25mm	45mm
	16mm	No 6 Type S Needle Point	30mm	45mm
Lightweight Steel 0.8mm to 1.6mm	13mm	No 6 Type D Drill Point	32mm	45mm
	16mm	No 6 Type D Drill Point	32mm	45mm

INSTALLATION DETAILS - STEEL STUD

LOAD BEARING WALL 60/60/60



Maintain 10mm gap between sheet perimeter. Caulk all perimeters with an Australian approved fire rated mastic.

**NOTE:**  
Fasteners 10-16mm from the edge unless otherwise noted.

Butt joints to be closed up to staggered 200mm for load bearing walls.

SCREW FIXINGS FOR LIGHTWEIGHT STEEL FRAMING			SCREW LENGTH
FRAMING	GTEK™ FIRE THICKNESS	SCREW TYPE	1ST LAYER
Lightweight Steel up to 0.8mm	13mm	No 6 Type S Needle Point	25mm
	16mm	No 6 Type S Needle Point	30mm
Lightweight Steel 0.8mm to 1.6mm	13mm	No 6 Type D Drill Point	32mm
	16mm	No 6 Type D Drill Point	32mm

**FIXING SPECIFICATIONS**

FASTENER SPACING	POSITION
300mm max. centres	Centre of the Board
At each stud	Recessed Edges
200mm max. centres	Butt Joints Staggered
200mm max. centres	Corners & Openings

**NOTE:**  
Recessed joints to be offset a minimum 300mm in opposing sides when not backed by a noggin.



TIMBER FRAME INTERIOR WALL SYSTEM – SINGLE STUD



TIMBER STUDS AT 600mm MAX CENTRES  
WITH NOGGINGS AT 1350mm MAX CENTRES

Side 1 1 x 10mm GTEK™ Wall  
Side 2 1 x 10mm GTEK™ Wall

GTEK-T001

FRL	CAVITY WIDTH mm	70	90	120	140
	CAVITY INFILL	Rw/Rw+Ctr			
-/-/-	Nil	31/25	32/26	33/27	33/27
	9kg - 50mm Glasswool	37/28	37/28	38/30	39/32
	30kg - 75mm Glasswool	-	38/29	39/30	39/32
	<b>WALL THICKNESS mm</b>	<b>90</b>	<b>110</b>	<b>140</b>	<b>160</b>



TIMBER STUDS AT 600mm MAX CENTRES  
WITH NOGGINGS AT 1350mm MAX CENTRES

Side 1 1 x 13mm GTEK™ Wall  
Side 2 1 x 13mm GTEK™ Wall

GTEK-T002

FRL	CAVITY WIDTH mm	70	90	120	140
	CAVITY INFILL	Rw/Rw+Ctr			
-/-/-	Nil	34/28	35/30	36/30	37/31
	9kg - 50mm Glasswool	39/32	40/32	41/35	41/35
	30kg - 75mm Glasswool	-	40/32	41/35	41/35
	<b>WALL THICKNESS mm</b>	<b>96</b>	<b>116</b>	<b>146</b>	<b>166</b>



TIMBER STUDS AT 600mm MAX CENTRES  
WITH NOGGINGS AT 1350mm MAX CENTRES

Side 1 2 x 10mm GTEK™ Wall  
Side 2 2 x 10mm GTEK™ Wall

GTEK-T004

FRL	CAVITY WIDTH mm	70	90	120	140
	CAVITY INFILL	Rw/Rw+Ctr			
-/-/-	Nil	39/31	39/33	40/33	41/34
	9kg - 50mm Glasswool	44/36	45/37	45/40	45/40
	30kg - 75mm Glasswool	-	45/38	45/40	46/40
	<b>WALL THICKNESS mm</b>	<b>90</b>	<b>110</b>	<b>140</b>	<b>160</b>

TIMBER FRAME INTERIOR WALL SYSTEM – SINGLE STUD



**TIMBER STUDS AT 600mm MAX CENTRES  
WITH NOGGINGS AT 1350mm MAX CENTRES**  
Side 1 2 x 13mm GTEK™ Wall  
Side 2 2 x 13mm GTEK™ Wall

**GTEK-T005**

FRL	CAVITY WIDTH mm	70	90	120	140
	CAVITY INFILL	Rw/Rw+Ctr			
-/-/-	Nil	41/35	43/37	43/37	44/37
	9kg - 50mm Glasswool	46/41	47/42	47/42	47/43
	30kg - 75mm Glasswool	-	47/42	47/43	47/43
	<b>WALL THICKNESS mm</b>	<b>122</b>	<b>142</b>	<b>172</b>	<b>192</b>



**TIMBER STUDS AT 600mm MAX CENTRES  
WITH NOGGINGS AT 1350mm MAX CENTRES**  
Side 1 1 x 10mm GTEK™ Sound  
Side 2 1 x 10mm GTEK™ Sound

**GTEK-T006**

FRL	CAVITY WIDTH mm	70	90	120	140
	CAVITY INFILL	Rw/Rw+Ctr			
-/-/-	Nil	34/29	35/29	35/29	36/30
	9kg - 50mm Glasswool	39/31	39/32	40/35	40/34
	30kg - 75mm Glasswool	-	39/32	40/35	40/35
	<b>WALL THICKNESS mm</b>	<b>90</b>	<b>110</b>	<b>140</b>	<b>160</b>



**TIMBER STUDS AT 600mm MAX CENTRES  
WITH NOGGINGS AT 1350mm MAX CENTRES**  
Side 1 1 x 13mm GTEK™ Sound  
Side 2 1 x 13mm GTEK™ Sound

**GTEK-T007**

FRL	CAVITY WIDTH mm	70	90	120	140
	CAVITY INFILL	Rw/Rw+Ctr			
-/-/-	Nil	36/31	37/31	38/33	38/33
	9kg - 50mm Glasswool	40/34	40/36	40/37	40/37
	30kg - 75mm Glasswool	-	41/36	41/37	41/38
	<b>WALL THICKNESS mm</b>	<b>96</b>	<b>116</b>	<b>146</b>	<b>166</b>

TIMBER FRAME INTERIOR WALL SYSTEM – SINGLE STUD



TIMBER STUDS AT 600mm MAX CENTRES  
WITH NOGGINGS AT 1350mm MAX CENTRES

Side 1 1 x 10mm GTEK™ Sound  
Side 2 1 x 10mm GTEK™ Wet Area

GTEK-T008

FRL	CAVITY WIDTH mm	70	90	120	140
	CAVITY INFILL	Rw/Rw+Ctr			
-/-/-	Nil	35/29	35/29	36/30	37/30
	9kg - 50mm Glasswool	39/31	40/31	41/35	41/34
	30kg - 75mm Glasswool	-	40/32	41/35	41/35
	<b>WALL THICKNESS mm</b>	<b>90</b>	<b>110</b>	<b>140</b>	<b>160</b>



TIMBER STUDS AT 600mm MAX CENTRES  
WITH NOGGINGS AT 1350mm MAX CENTRES

Side 1 2 x 10mm GTEK™ Sound  
Side 2 2 x 10mm GTEK™ Sound

GTEK-T010

FRL	CAVITY WIDTH mm	70	90	120	140
	CAVITY INFILL	Rw/Rw+Ctr			
-/-/-	Nil	43/37	44/37	44/38	45/39
	9kg - 50mm Glasswool	47/41	48/43	48/44	48/44
	30kg - 75mm Glasswool	-	48/43	48/44	48/44
	<b>WALL THICKNESS mm</b>	<b>110</b>	<b>130</b>	<b>160</b>	<b>180</b>



TIMBER STUDS AT 600mm MAX CENTRES  
WITH NOGGINGS AT 1350mm MAX CENTRES

Side 1 1 x 13mm GTEK™ Fire  
Side 2 1 x 13mm GTEK™ Fire

Previously BGC 005

GTEK-T011

FRL	CAVITY WIDTH mm	70	90	120	140
	CAVITY INFILL	Rw/Rw+Ctr			
-/60/60	Nil	35/30	36/31	37/32	38/33
	9kg - 50mm Glasswool	40/32	41/35	41/36	41/37
	30kg - 75mm Glasswool	-	41/35	41/36	42/37
	<b>WALL THICKNESS mm</b>	<b>96</b>	<b>116</b>	<b>146</b>	<b>166</b>

TIMBER FRAME INTERIOR WALL SYSTEM – SINGLE STUD



**TIMBER STUDS AT 600mm MAX CENTRES  
WITH NOGGINGS AT 1350mm MAX CENTRES**  
Side 1 1 x 13mm GTEK™ Wall  
Side 2 1 x 10mm GTEK™ Wall  
1 x 13mm GTEK™ Fire

**GTEK-T015**

FRL	CAVITY WIDTH mm	70	90	120	140
	CAVITY INFILL	Rw/Rw+Ctr			
-/-/-	Nil	37/31	37/31	39/33	39/32
	9kg - 50mm Glasswool	41/33	42/36	43/37	43/38
	30kg - 75mm Glasswool	-	42/37	43/38	43/39
	<b>WALL THICKNESS mm</b>	<b>106</b>	<b>126</b>	<b>156</b>	<b>176</b>



**TIMBER STUDS AT 600mm MAX CENTRES  
WITH NOGGINGS AT 1350mm MAX CENTRES**  
Side 1 1 x 16mm GTEK™ Fire  
Side 2 1 x 16mm GTEK™ Fire

**GTEK-T019**

FRL	CAVITY WIDTH mm	70	90	120	140
	CAVITY INFILL	Rw/Rw+Ctr			
-/60/60 60/60/60	Nil	36/31	37/31	38/33	38/33
	9kg - 50mm Glasswool	40/34	40/36	40/37	40/37
	30kg - 75mm Glasswool	-	41/36	41/37	41/38
	<b>WALL THICKNESS mm</b>	<b>102</b>	<b>122</b>	<b>152</b>	<b>172</b>



**TIMBER STUDS AT 600mm MAX CENTRES  
WITH NOGGINGS AT 1350mm MAX CENTRES**  
Side 1 2 x 13mm GTEK™ Fire  
Side 2 2 x 13mm GTEK™ Fire

**GTEK-T021**

FRL	CAVITY WIDTH mm	70	90	120	140
	CAVITY INFILL	Rw/Rw+Ctr			
90/90/90 -/120/120	Nil	44/39	44/39	45/40	46/40
	9kg - 50mm Glasswool	48/43	48/44	48/45	48/45
	30kg - 75mm Glasswool	-	48/44	48/45	48/45
	<b>WALL THICKNESS mm</b>	<b>122</b>	<b>142</b>	<b>172</b>	<b>192</b>



TIMBER FRAME INTERIOR WALL SYSTEM – SINGLE STUD



TIMBER STUDS AT 600mm MAX CENTRES  
WITH NOGGINGS AT 1350mm MAX CENTRES

Side 1 2 x 16mm GTEK™ Fire  
Side 2 1 x 16mm GTEK™ Fire

GTEK-T022

FRL	CAVITY WIDTH mm	70	90	120	140
	CAVITY INFILL	Rw/Rw+Ctr			
-/60/60	Nil	40/35	41/37	42/37	42/37
	9kg - 50mm Glasswool	44/39	44/40	44/41	44/41
	30kg - 75mm Glasswool	-	44/41	44/41	44/41
	<b>WALL THICKNESS mm</b>	<b>122</b>	<b>142</b>	<b>172</b>	<b>192</b>



TIMBER STUDS AT 600mm MAX CENTRES  
WITH NOGGINGS AT 1350mm MAX CENTRES

Side 1 2 x 16mm GTEK™ Fire  
Side 2 2 x 16mm GTEK™ Fire

GTEK-T023

FRL	CAVITY WIDTH mm	70	90	120	140
	CAVITY INFILL	Rw/Rw+Ctr			
90/90/90 -/120/120	Nil	45/40	46/40	46/41	47/42
	9kg - 50mm Glasswool	48/45	48/45	48/45	48/45
	30kg - 75mm Glasswool	-	48/45	48/45	48/45
	<b>WALL THICKNESS mm</b>	<b>134</b>	<b>154</b>	<b>184</b>	<b>204</b>



TIMBER STUDS AT 600mm MAX CENTRES  
WITH NOGGINGS AT 1350mm MAX CENTRES

Side 1 3 x 16mm GTEK™ Fire  
Side 2 3 x 16mm GTEK™ Fire

GTEK-T026

FRL	CAVITY WIDTH mm	70	90	120	140
	CAVITY INFILL	Rw/Rw+Ctr			
-/180/180	Nil	50/44	50/45	51/46	51/46
	9kg - 50mm Glasswool	51/49	51/49	51/49	51/49
	30kg - 75mm Glasswool	-	51/49	51/49	51/49
	<b>WALL THICKNESS mm</b>	<b>134</b>	<b>154</b>	<b>184</b>	<b>204</b>

TIMBER FRAME INTERIOR WALL SYSTEM – SINGLE STUD



**TIMBER STUDS AT 600mm MAX CENTRES  
WITH NOGGINGS AT 1350mm MAX CENTRES**

Side 1 1 x 6mm BGC Duraliner™ Plus  
Side 2 1 x 6mm BGC Duraliner™ Plus

**GTEK-T027**

FRL	CAVITY WIDTH mm	70	90	120	140
	CAVITY INFILL	Rw/Rw+Ctr			
-/-/-	Nil	33/26	33/26	34/27	34/27
	9kg - 50mm Glasswool	40/30	41/31	42/34	42/34
	30kg - 75mm Glasswool	-	41/31	43/34	43/34
	<b>WALL THICKNESS mm</b>	<b>82</b>	<b>102</b>	<b>132</b>	<b>152</b>



**TIMBER STUDS AT 600mm MAX CENTRES  
WITH NOGGINGS AT 1350mm MAX CENTRES**

Side 1 1 x 10mm GTEK™ Sound (against stud)  
1 x 6mm BGC Duraliner™ Plus  
Side 2 1 x 10mm GTEK™ Sound (against stud)  
1 x 6mm BGC Duraliner™ Plus

**GTEK-T037**

FRL	CAVITY WIDTH mm	70	90	120	140
	CAVITY INFILL	Rw/Rw+Ctr			
-/-/-	Nil	41/34	42/36	43/36	43/36
	9kg - 50mm Glasswool	46/39	47/41	47/42	47/42
	30kg - 75mm Glasswool	-	47/41	47/42	47/43
	<b>WALL THICKNESS mm</b>	<b>102</b>	<b>122</b>	<b>152</b>	<b>172</b>



**TIMBER STUDS AT 600mm MAX CENTRES  
WITH NOGGINGS AT 1350mm MAX CENTRES**

Side 1 1 x 6mm BGC Duraliner™ Plus (against stud)  
1 x 13mm GTEK™ Fire  
Side 2 1 x 6mm BGC Duraliner™ Plus (against stud)  
1 x 13mm GTEK™ Fire

**GTEK-T039**

FRL	CAVITY WIDTH mm	70	90	120	140
	CAVITY INFILL	Rw/Rw+Ctr			
-/90/90 60/60/60	Nil	42/36	43/37	44/38	44/38
	9kg - 50mm Glasswool	47/41	47/43	48/43	48/44
	30kg - 75mm Glasswool	-	48/43	48/44	48/44
	<b>WALL THICKNESS mm</b>	<b>108</b>	<b>128</b>	<b>158</b>	<b>178</b>

TIMBER FRAME INTERIOR WALL SYSTEM – SINGLE STUD



**TIMBER STUDS AT 600mm MAX CENTRES  
WITH NOGGINGS AT 1350mm MAX CENTRES**  
 Side 1 1 x 6mm BGC Duraliner™ Plus (against stud)  
 1 x 16mm GTEK™ Fire  
 Side 2 1 x 6mm BGC Duraliner™ Plus (against stud)  
 1 x 16mm GTEK™ Fire

**GTEK-T042**

FRL	CAVITY WIDTH mm	70	90	120	140
	CAVITY INFILL	Rw/Rw+Ctr			
-/120/120 90/90/90	Nil	44/39	45/39	46/40	46/40
	9kg - 50mm Glasswool	48/43	48/44	48/45	48/45
	30kg - 75mm Glasswool	-	48/44	48/45	48/45
	<b>WALL THICKNESS mm</b>	<b>114</b>	<b>134</b>	<b>164</b>	<b>184</b>



**TIMBER STUDS AT 600mm MAX CENTRES  
WITH NOGGINGS AT 1350mm MAX CENTRES**  
 Side 1 2 x 16mm GTEK™ Fire & Wet Area  
 Side 2 2 x 16mm GTEK™ Fire & Wet Area

**GTEK-T044**

FRL	CAVITY WIDTH mm	70	90	120	140
	CAVITY INFILL	Rw/Rw+Ctr			
-/180/180	Nil	45/40	46/40	46/41	47/42
	9kg - 50mm Glasswool	48/45	48/45	48/45	48/45
	30kg - 75mm Glasswool	-	48/45	48/45	48/45
	<b>WALL THICKNESS mm</b>	<b>114</b>	<b>134</b>	<b>164</b>	<b>184</b>



**TIMBER STUDS AT 600mm MAX CENTRES  
WITH NOGGINGS AT 1350mm MAX CENTRES**  
 Side 1 1 x 13mm GTEK™ Total Plus  
 Side 2 1 x 13mm GTEK™ Total Plus

**GTEK-E5T001**

FRL	CAVITY WIDTH mm	70	90	120	140
	CAVITY INFILL	Rw/Rw+Ctr			
-/60/60	Nil	36/31	37/31	38/33	38/33
	9kg - 50mm Glasswool	40/34	40/36	40/37	40/37
	11kg - 75mm Glasswool	40/34	40/36	40/37	40/37
	30kg - 75mm Glasswool	40/34	41/36	41/37	41/38
	<b>WALL THICKNESS mm</b>	<b>114</b>	<b>134</b>	<b>164</b>	<b>184</b>

TIMBER FRAME INTERIOR WALL SYSTEM – SINGLE STUD



TIMBER STUDS AT 600mm MAX CENTRES  
WITH NOGGINGS AT 1350mm MAX CENTRES  
Side 1  
Side 2 2 x 16mm GTEK™ Fire

GTEK-T046

FRL	CAVITY WIDTH mm	70	90	120	140
	CAVITY INFILL	Rw/Rw+Ctr			
-/60/60	Nil	35/32	-	-	-
	9kg - 50mm Glasswool	-	-	-	-
	30kg - 75mm Glasswool	-	-	-	-
	<b>WALL THICKNESS mm</b>	<b>102</b>	<b>122</b>	<b>152</b>	<b>172</b>



TIMBER STUDS AT 600mm MAX CENTRES  
WITH NOGGINGS AT 1350mm MAX CENTRES  
Side 1  
Side 2 3 x 16mm GTEK™ Fire

GTEK-T048

FRL	CAVITY WIDTH mm	70	90	120	140
	CAVITY INFILL	Rw/Rw+Ctr			
-/90/90	Nil	38/36	-	-	-
	9kg - 50mm Glasswool	-	-	-	-
	30kg - 75mm Glasswool	-	-	-	-
	<b>WALL THICKNESS mm</b>	<b>118</b>	<b>138</b>	<b>168</b>	<b>188</b>

TIMBER FRAME INTERIOR WALL SYSTEM – STAGGERED STUD



STAGGERED TIMBER STUDS AT 600mm MAX CENTRES  
MIN 20mm CLEARANCE BETWEEN STUD AND  
OPPOSING WALL LINING

Side 1 1 x 10mm GTEK™ Sound  
Side 2 1 x 10mm GTEK™ Sound

GTEK-TS006

FRL	CAVITY WIDTH mm	90	120	140
	CAVITY INFILL	Rw/Rw+Ctr		
-/-/-	Nil	33/27	34/28	35/29
	9kg - 50mm Glasswool	43/34	45/38	45/37
	30kg - 75mm Glasswool	44/34	46/38	46/38
	<b>WALL THICKNESS mm</b>	<b>110</b>	<b>140</b>	<b>160</b>



STAGGERED TIMBER STUDS AT 600mm MAX CENTRES  
MIN 20mm CLEARANCE BETWEEN STUD AND  
OPPOSING WALL LINING

Side 1 2 x 10mm GTEK™ Sound  
Side 2 2 x 10mm GTEK™ Sound

GTEK-TS010

FRL	CAVITY WIDTH mm	90	120	140
	CAVITY INFILL	Rw/Rw+Ctr		
-/-/-	Nil	42/35	43/36	44/36
	9kg - 50mm Glasswool	52/45	52/46	53/47
	30kg - 75mm Glasswool	52/45	53/47	53/47
	<b>WALL THICKNESS mm</b>	<b>130</b>	<b>160</b>	<b>180</b>



STAGGERED TIMBER STUDS AT 600mm MAX CENTRES  
MIN 20mm CLEARANCE BETWEEN STUD AND  
OPPOSING WALL LINING

Side 1 1 x 13mm GTEK™ Fire  
Side 2 1 x 13mm GTEK™ Fire

GTEK-TS011

FRL	CAVITY WIDTH mm	90	120	140
	CAVITY INFILL	Rw/Rw+Ctr		
-/60/60	Nil	35/29	37/31	37/32
	9kg - 50mm Glasswool	45/37	46/38	46/40
	30kg - 75mm Glasswool	45/37	46/39	47/40
	<b>WALL THICKNESS mm</b>	<b>116</b>	<b>146</b>	<b>166</b>

TIMBER FRAME INTERIOR WALL SYSTEM – STAGGERED STUD



STAGGERED TIMBER STUDS AT 600mm MAX CENTRES  
MIN 20mm CLEARANCE BETWEEN STUD AND  
OPPOSING WALL LINING

Side 1 1 x 16mm GTEK™ Fire  
Side 2 1 x 16mm GTEK™ Fire

GTEK-TS019

FRL	CAVITY WIDTH mm	90	120	140
	CAVITY INFILL	Rw/Rw+Ctr		
-/90/90	Nil	36/30	38/32	38/32
	9kg - 50mm Glasswool	46/39	46/40	46/41
	30kg - 75mm Glasswool	46/39	46/40	47/42
	<b>WALL THICKNESS mm</b>	<b>122</b>	<b>152</b>	<b>172</b>



STAGGERED TIMBER STUDS AT 600mm MAX CENTRES  
MIN 20mm CLEARANCE BETWEEN STUD AND  
OPPOSING WALL LINING

Side 1 2 x 13mm GTEK™ Fire  
Side 2 2 x 13mm GTEK™ Fire

GTEK-TS021

FRL	CAVITY WIDTH mm	90	120	140
	CAVITY INFILL	Rw/Rw+Ctr		
-/120/120	Nil	42/36	43/37	44/37
	9kg - 50mm Glasswool	52/46	53/48	53/48
	30kg - 75mm Glasswool	53/47	53/48	53/49
	<b>WALL THICKNESS mm</b>	<b>142</b>	<b>172</b>	<b>192</b>



STAGGERED TIMBER STUDS AT 600mm MAX CENTRES  
MIN 20mm CLEARANCE BETWEEN STUD AND  
OPPOSING WALL LINING

Side 1 2 x 16mm GTEK™ Fire  
Side 2 2 x 16mm GTEK™ Fire

GTEK-TS023

FRL	CAVITY WIDTH mm	90	120	140
	CAVITY INFILL	Rw/Rw+Ctr		
-/120/120	Nil	43/37	45/38	45/38
	9kg - 50mm Glasswool	53/48	53/49	53/49
	30kg - 75mm Glasswool	53/49	53/50	53/50
	<b>WALL THICKNESS mm</b>	<b>154</b>	<b>184</b>	<b>204</b>

TIMBER FRAME INTERIOR WALL SYSTEM – STAGGERED STUD



STAGGERED TIMBER STUDS AT 600mm MAX CENTRES  
MIN 20mm CLEARANCE BETWEEN STUD AND  
OPPOSING WALL LINING

Side 1 1 x 6mm BGC Duraliner™ Plus  
Side 2 1 x 6mm BGC Duraliner™ Plus

GTEK-TS027

FRL	CAVITY WIDTH mm	90	120	140
	CAVITY INFILL	Rw/Rw+Ctr		
-/-/-	Nil	33/26	33/25	33/26
	9kg - 50mm Glasswool	43/31	45/35	45/35
	30kg - 75mm Glasswool	43/31	45/35	46/35
	<b>WALL THICKNESS mm</b>	<b>102</b>	<b>132</b>	<b>152</b>



STAGGERED TIMBER STUDS AT 600mm MAX CENTRES  
MIN 20mm CLEARANCE BETWEEN STUD AND  
OPPOSING WALL LINING

Side 1 1 x 9mm BGC Duraliner™ Plus  
Side 2 1 x 9mm BGC Duraliner™ Plus

GTEK-TS028

FRL	CAVITY WIDTH mm	90	120	140
	CAVITY INFILL	Rw/Rw+Ctr		
-/-/-	Nil	37/30	39/32	39/31
	9kg - 50mm Glasswool	47/38	48/39	48/40
	30kg - 75mm Glasswool	47/38	48/40	48/40
	<b>WALL THICKNESS mm</b>	<b>108</b>	<b>138</b>	<b>158</b>



STAGGERED TIMBER STUDS AT 600mm MAX CENTRES  
MIN 20mm CLEARANCE BETWEEN STUD AND  
OPPOSING WALL LINING

Side 1 1 x 6mm BGC Duraliner™ Plus  
Side 2 1 x 10mm GTEK™ Wall

GTEK-TS030

FRL	CAVITY WIDTH mm	90	120	140
	CAVITY INFILL	Rw/Rw+Ctr		
-/-/-	Nil	32/25	33/26	33/26
	9kg - 50mm Glasswool	42/31	44/34	45/36
	30kg - 75mm Glasswool	43/31	45/34	46/35
	<b>WALL THICKNESS mm</b>	<b>106</b>	<b>136</b>	<b>156</b>

TIMBER FRAME INTERIOR WALL SYSTEM – STAGGERED STUD



**STAGGERED TIMBER STUDS AT 600mm MAX CENTRES  
MIN 20mm CLEARANCE BETWEEN STUD AND  
OPPOSING WALL LINING**

- Side 1 1 x 6mm BGC Duraliner™ Plus
- Side 2 1 x 10mm GTEK™ Sound

**GTEK-TS031**

FRL	CAVITY WIDTH mm	90	120	140
	CAVITY INFILL	Rw/Rw+Ctr		
-/-/-	Nil	33/26	33/26	34/27
	9kg - 50mm Glasswool	43/32	45/36	45/35
	30kg - 75mm Glasswool	43/32	46/36	46/36
	<b>WALL THICKNESS mm</b>	<b>106</b>	<b>136</b>	<b>156</b>



**STAGGERED TIMBER STUDS AT 600mm MAX CENTRES  
MIN 20mm CLEARANCE BETWEEN STUD AND  
OPPOSING WALL LINING**

- Side 1 1 x 6mm BGC Duraliner™ Plus (against stud)  
1 x 13mm GTEK™ Fire
- Side 2 1 x 6mm BGC Duraliner™ Plus (against stud)  
1 x 13mm GTEK™ Fire

**GTEK-TS039**

FRL	CAVITY WIDTH mm	90	120	140
	CAVITY INFILL	Rw/Rw+Ctr		
60/60/60	Nil	42/34	43/35	43/36
	9kg - 50mm Glasswool	52/46	53/47	53/47
	30kg - 75mm Glasswool	53/46	53/47	53/47
	<b>WALL THICKNESS mm</b>	<b>128</b>	<b>158</b>	<b>178</b>



**STAGGERED TIMBER STUDS AT 600mm MAX CENTRES  
MIN 20mm CLEARANCE BETWEEN STUD AND  
OPPOSING WALL LINING**

- Side 1 1 x 16mm GTEK™ Fire (against stud)  
1 x 6mm BGC Duraliner™ Plus
- Side 2 1 x 16mm GTEK™ Fire (against stud)  
1 x 6mm BGC Duraliner™ Plus

**GTEK-TS040**

FRL	CAVITY WIDTH mm	90	120	140
	CAVITY INFILL	Rw/Rw+Ctr		
60/60/60	Nil	42/34	43/36	44/36
	9kg - 50mm Glasswool	52/46	53/48	53/48
	30kg - 75mm Glasswool	53/47	53/48	53/49
	<b>WALL THICKNESS mm</b>	<b>134</b>	<b>164</b>	<b>184</b>



TIMBER FRAME INTERIOR WALL SYSTEM – STAGGERED STUD



**STAGGERED TIMBER STUDS AT 600mm MAX CENTRES  
MIN 20mm CLEARANCE BETWEEN STUD AND  
OPPOSING WALL LINING**

Side 1 1 x 6mm BGC Duraliner™ Plus (against stud)  
1 x 16mm GTEK™ Fire

Side 2 1 x 6mm BGC Duraliner™ Plus (against stud)  
1 x 16mm GTEK™ Fire

Previously BGC DL004

**GTEK-TS042**

FRL	CAVITY WIDTH mm	90	120	140
	CAVITY INFILL	Rw/Rw+Ctr		
90/90/90 -/120/120	Nil	42/34	43/36	44/36
	9kg - 50mm Glasswool	52/46	53/48	53/48
	30kg - 75mm Glasswool	53/47	53/48	53/49
	<b>WALL THICKNESS mm</b>	<b>134</b>	<b>164</b>	<b>184</b>

TIMBER FRAME INTERIOR WALL SYSTEM – DOUBLE STUD



MIN 20mm GAP BETWEEN STUD WALLS  
 2 ROWS OF TIMBER STUDS AT 600mm MAX CENTRES  
 Side 1 1 x 13mm GTEK™ Fire  
 Side 2 1 x 13mm GTEK™ Fire

GTEK-TD011

FRL	CAVITY WIDTH mm	160	200	260	300
	CAVITY INFILL	Rw/Rw+Ctr			
-/60/60	Nil	40/34	42/35	43/35	44/36
	9kg - 50mm Glasswool - 1 side	52/44	53/45	53/47	53/47
	9kg - 50mm Glasswool - 2 sides	54/45	55/47	55/48	55/49
	30kg - 75mm Glasswool - 1 side	55/45	56/48	56/48	56/49
	30kg - 75mm Glasswool - 2 sides	57/46	58/48	59/49	59/49
	WALL THICKNESS mm	186	226	286	326



MIN 20mm GAP BETWEEN STUD WALLS  
 2 ROWS OF TIMBER STUDS AT 600mm MAX CENTRES  
 Side 1 1 x 13mm GTEK™ Wall (against stud)  
 1 x 13mm GTEK™ Fire  
 Side 2 1 x 13mm GTEK™ Wall (against stud)  
 1 x 13mm GTEK™ Fire

GTEK-TD013

FRL	CAVITY WIDTH mm	160	200	260	300
	CAVITY INFILL	Rw/Rw+Ctr			
-/60/60	Nil	46/37	47/38	48/38	49/39
	9kg - 50mm Glasswool - 1 side	57/48	57/49	58/49	58/51
	9kg - 50mm Glasswool - 2 sides	60/50	61/52	61/53	61/53
	30kg - 75mm Glasswool - 1 side	61/50	61/52	62/54	62/55
	30kg - 75mm Glasswool - 2 sides	63/52	64/54	65/55	65/55
	WALL THICKNESS mm	212	252	312	352



MIN 20mm GAP BETWEEN STUD WALLS  
 2 ROWS OF TIMBER STUDS AT 600mm MAX CENTRES  
 Side 1 1 x 10mm GTEK™ Wall (against stud)  
 1 x 16mm GTEK™ Fire  
 Side 2 1 x 10mm GTEK™ Wall (against stud)  
 1 x 16mm GTEK™ Fire

GTEK-TD017

FRL	CAVITY WIDTH mm	160	200	260	300
	CAVITY INFILL	Rw/Rw+Ctr			
-/60/60	Nil	46/38	47/39	48/39	49/40
	9kg - 50mm Glasswool - 1 side	57/49	58/49	58/49	58/51
	9kg - 50mm Glasswool - 2 sides	60/51	61/52	61/53	61/53
	30kg - 75mm Glasswool - 1 side	61/51	62/53	63/54	63/55
	30kg - 75mm Glasswool - 2 sides	63/52	64/54	65/55	65/55
	WALL THICKNESS mm	212	252	312	352

TIMBER FRAME INTERIOR WALL SYSTEM – DOUBLE STUD



MIN 20mm GAP BETWEEN STUD WALLS  
 2 ROWS OF TIMBER STUDS AT 600mm MAX CENTRES  
 Side 1 1 x 16mm GTEK™ Fire  
 Side 2 1 x 16mm GTEK™ Fire

GTEK-TD019

FRL	CAVITY WIDTH mm	160	200	260	300
	CAVITY INFILL	Rw/Rw+Ctr			
-/60/60 60/60/60	Nil	42/35	43/36	45/37	45/37
	9kg - 50mm Glasswool - 1 side	54/46	55/48	55/49	55/49
	9kg - 50mm Glasswool - 2 sides	56/48	57/49	57/49	57/50
	30kg - 75mm Glasswool - 1 side	57/48	58/49	58/49	58/51
	30kg - 75mm Glasswool - 2 sides	59/48	60/49	61/50	61/51
	<b>WALL THICKNESS mm</b>	<b>192</b>	<b>232</b>	<b>292</b>	<b>332</b>



MIN 20mm GAP BETWEEN STUD WALLS  
 2 ROWS OF TIMBER STUDS AT 600mm MAX CENTRES  
 Side 1 2 x 13mm GTEK™ Fire  
 Side 2 2 x 13mm GTEK™ Fire

GTEK-TD021

FRL	CAVITY WIDTH mm	160	200	260	300
	CAVITY INFILL	Rw/Rw+Ctr			
-/120/120 90/90/90	Nil	48/40	50/41	51/43	52/43
	9kg - 50mm Glasswool - 1 side	60/51	60/53	61/55	61/55
	9kg - 50mm Glasswool - 2 sides	62/53	63/55	63/56	63/57
	30kg - 75mm Glasswool - 1 side	63/53	64/55	64/56	64/57
	30kg - 75mm Glasswool - 2 sides	65/54	65/55	66/57	66/58
	<b>WALL THICKNESS mm</b>	<b>212</b>	<b>252</b>	<b>312</b>	<b>352</b>



MIN 20mm GAP BETWEEN STUD WALLS  
 2 ROWS OF TIMBER STUDS AT 600mm MAX CENTRES  
 Side 1 2 x 16mm GTEK™ Fire  
 Side 2 2 x 16mm GTEK™ Fire

GTEK-TD023

FRL	CAVITY WIDTH mm	160	200	260	300
	CAVITY INFILL	Rw/Rw+Ctr			
90/90/90 -/120/120	Nil	48/39	49/41	51/42	52/43
	9kg - 50mm Glasswool - 1 side	60/52	61/54	61/55	61/56
	9kg - 50mm Glasswool - 2 sides	62/54	63/55	64/57	64/57
	30kg - 75mm Glasswool - 1 side	63/54	64/56	65/57	65/58
	30kg - 75mm Glasswool - 2 sides	65/54	66/57	67/58	67/59
	<b>WALL THICKNESS mm</b>	<b>224</b>	<b>264</b>	<b>324</b>	<b>364</b>

TIMBER FRAME INTERIOR WALL SYSTEM – DOUBLE STUD



MIN 20mm GAP BETWEEN STUD WALLS  
 2 ROWS OF TIMBER STUDS AT 600mm MAX CENTRES  
 Side 1 3 x 16mm GTEK™ Fire  
 Side 2 3 x 16mm GTEK™ Fire

GTEK-TD026

FRL	CAVITY WIDTH mm	160	200	260	300
	CAVITY INFILL	Rw/Rw+Ctr			
-/120/120	Nil	54/45	56/46	58/48	59/49
	9kg - 50mm Glasswool - 1 side	67/59	68/61	69/62	69/63
	9kg - 50mm Glasswool - 2 sides	69/61	70/62	71/64	71/65
	30kg - 75mm Glasswool - 1 side	70/61	71/63	72/64	72/65
	30kg - 75mm Glasswool - 2 sides	72/61	73/63	73/65	73/65
	WALL THICKNESS mm	256	296	356	396



MIN 20mm GAP BETWEEN STUD WALLS  
 2 ROWS OF TIMBER STUDS AT 600mm MAX CENTRES  
 Side 1 1 x 6mm BGC Duraliner™ Plus  
 Side 2 1 x 6mm BGC Duraliner™ Plus

GTEK-TD027

FRL	CAVITY WIDTH mm	160	200	260	300
	CAVITY INFILL	Rw/Rw+Ctr			
-/-/-	Nil	38/30	38/31	39/32	40/32
	9kg - 50mm Glasswool - 1 side	51/41	51/43	52/44	52/45
	9kg - 50mm Glasswool - 2 sides	52/42	53/45	54/46	54/46
	30kg - 75mm Glasswool - 1 side	53/42	54/45	55/47	55/47
	30kg - 75mm Glasswool - 2 sides	55/43	56/46	57/48	57/49
	WALL THICKNESS mm	172	212	272	312



MIN 20mm GAP BETWEEN STUD WALLS  
 2 ROWS OF TIMBER STUDS AT 600mm MAX CENTRES  
 Side 1 1 x 9mm BGC Duraliner™ Plus  
 Side 2 1 x 9mm BGC Duraliner™ Plus

GTEK-TD028

FRL	CAVITY WIDTH mm	160	200	260	300
	CAVITY INFILL	Rw/Rw+Ctr			
-/-/-	Nil	42/34	43/35	44/36	45/36
	9kg - 50mm Glasswool - 1 side	55/45	55/46	56/48	56/48
	9kg - 50mm Glasswool - 2 sides	56/46	57/48	58/49	58/50
	30kg - 75mm Glasswool - 1 side	58/47	58/49	58/49	58/51
	30kg - 75mm Glasswool - 2 sides	59/47	60/49	61/49	61/52
	WALL THICKNESS mm	178	218	278	318

TIMBER FRAME INTERIOR WALL SYSTEM – DOUBLE STUD



**MIN 20mm GAP BETWEEN STUD WALLS**  
**2 ROWS OF TIMBER STUDS AT 600mm MAX CENTRES**  
 Side 1 1 x 6mm BGC Duraliner™ Plus (against studs)  
 1 x 13mm GTEK™ Fire  
 Side 2 1 x 6mm BGC Duraliner™ Plus (against studs)  
 1 x 13mm GTEK™ Fire

Previously BGC DL003

**GTEK-TD039**

FRL	CAVITY WIDTH mm	160	200	260	300
	CAVITY INFILL	Rw/Rw+Ctr			
60/60/60	Nil	46/38	47/39	48/39	49/40
	9kg - 50mm Glasswool - 1 side	58/49	59/49	59/49	59/51
	9kg - 50mm Glasswool - 2 sides	60/50	60/52	61/53	61/53
	30kg - 75mm Glasswool - 1 side	61/51	62/53	63/54	63/54
	30kg - 75mm Glasswool - 2 sides	63/52	64/53	65/55	65/55
	<b>WALL THICKNESS mm</b>	<b>198</b>	<b>238</b>	<b>298</b>	<b>338</b>



**MIN 20mm GAP BETWEEN STUD WALLS**  
**2 ROWS OF TIMBER STUDS AT 600mm MAX CENTRES**  
 Side 1 1 x 16mm GTEK™ Fire (against stud)  
 1 x 6mm BGC Duraliner™ Plus  
 Side 2 1 x 16mm GTEK™ Fire (against stud)  
 1 x 6mm BGC Duraliner™ Plus

**GTEK-TD040**

FRL	CAVITY WIDTH mm	160	200	260	300
	CAVITY INFILL	Rw/Rw+Ctr			
60/60/60	Nil	48/39	49/40	51/41	52/42
	9kg - 50mm Glasswool - 1 side	60/51	61/53	61/54	61/55
	9kg - 50mm Glasswool - 2 sides	62/53	63/54	63/56	63/57
	30kg - 75mm Glasswool - 1 side	63/53	64/54	64/56	64/57
	30kg - 75mm Glasswool - 2 sides	65/53	65/55	66/57	66/58
	<b>WALL THICKNESS mm</b>	<b>204</b>	<b>244</b>	<b>304</b>	<b>344</b>



**MIN 20mm GAP BETWEEN STUD WALLS**  
**2 ROWS OF TIMBER STUDS AT 600mm MAX CENTRES**  
 Side 1 1 x 6mm BGC Duraliner™ Plus (against studs)  
 1 x 16mm GTEK™ Fire  
 Side 2 1 x 6mm BGC Duraliner™ Plus (against studs)  
 1 x 16mm GTEK™ Fire

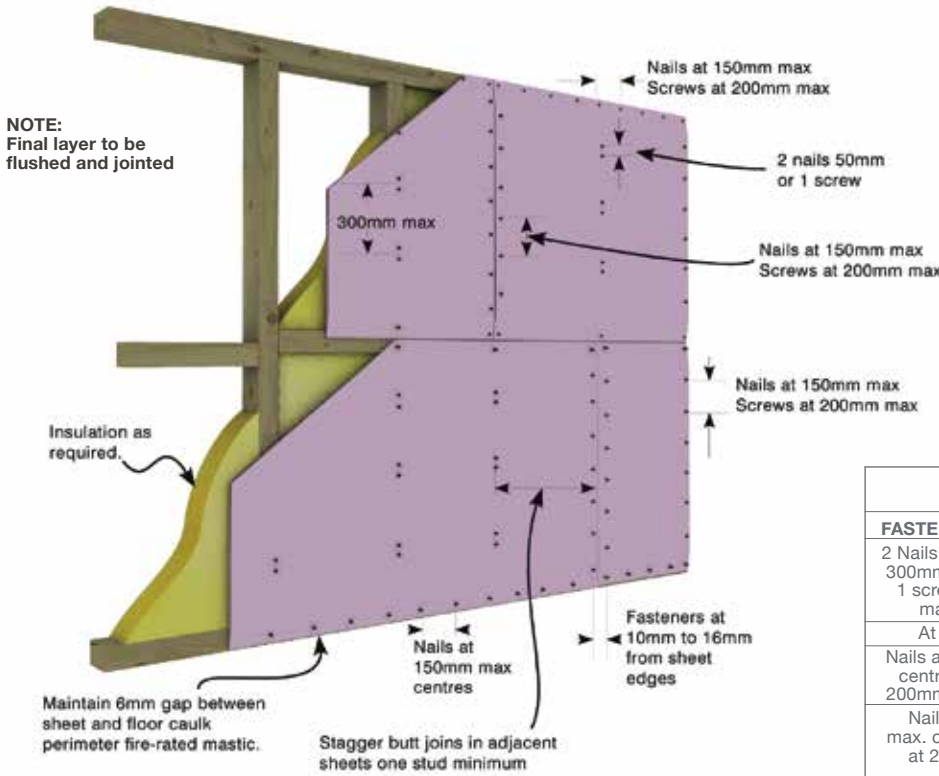
Previously BGC DL004

**GTEK-TD042**

FRL	CAVITY WIDTH mm	160	200	260	300
	CAVITY INFILL	Rw/Rw+Ctr			
90/90/90	Nil	48/39	49/40	51/41	52/42
	9kg - 50mm Glasswool - 1 side	60/51	61/53	61/54	61/55
	9kg - 50mm Glasswool - 2 sides	62/53	63/54	63/56	63/57
	30kg - 75mm Glasswool - 1 side	63/53	64/54	64/56	64/57
	30kg - 75mm Glasswool - 2 sides	65/53	65/55	66/57	66/58
	<b>WALL THICKNESS mm</b>	<b>204</b>	<b>244</b>	<b>304</b>	<b>344</b>

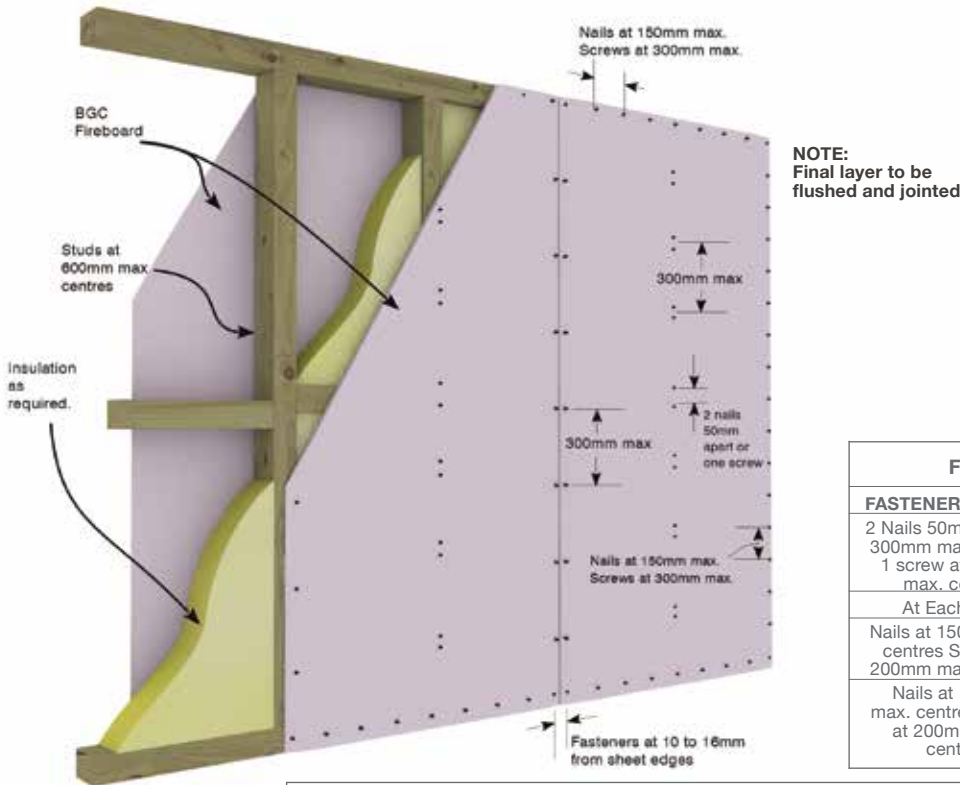
INSTALLATION DETAILS - TIMBER STUD

TIMBER FRAME WITH ONE LAYER GTEK™ FIRE - HORIZONTAL SHEETING



FIXING SPECIFICATIONS	
FASTENER SPACING	LOCATION
2 Nails 50mm apart at 300mm max. centres 1 screw at 200mm max. centres	Centre of the Board
At Each Stud	Recessed Edges
Nails at 150mm max. centres Screws at 200mm max. centres	Butt Joints
Nails at 150mm max. centres Screws at 200mm max. centres	Corners & Openings

TIMBER FRAME WITH ONE LAYER GTEK™ FIRE - VERTICAL SHEETING

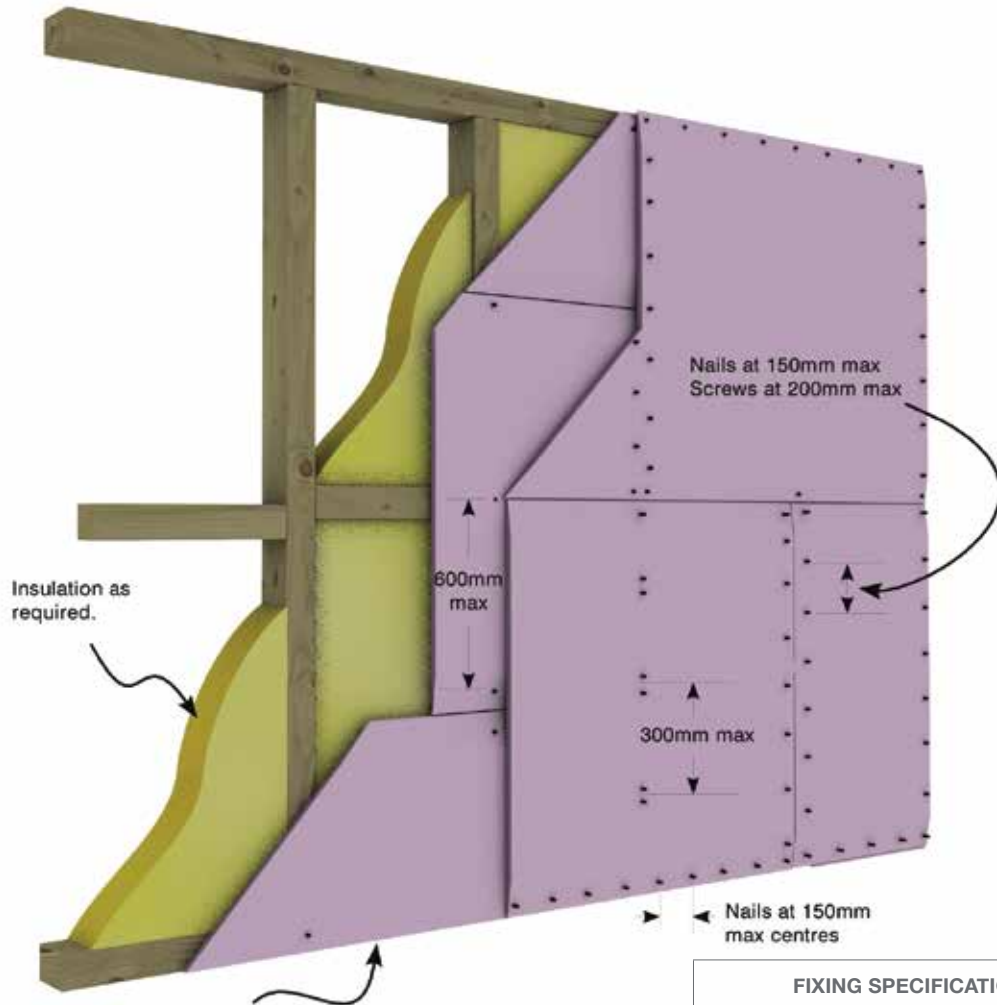


FIXING SPECIFICATIONS	
FASTENER SPACING	LOCATION
2 Nails 50mm apart at 300mm max. centres 1 screw at 200mm max. centres	Centre of the Board
At Each Stud	Recessed Edges
Nails at 150mm max. centres Screws at 200mm max. centres	Butt Joints
Nails at 150mm max. centres Screws at 200mm max. centres	Corners & Openings

SCREW FIXINGS FOR SOFT WOOD TIMBER FRAMING				SCREW LENGTH
FRAMING	GTEK™ FIRE THICKNESS	SCREW	NAIL	1ST LAYER
Soft Wood Timber	13mm	No. 6 Type W	2.8x50mm Hot Dipped Gal Clouts or equal	32mm
	16mm			45mm

INSTALLATION DETAILS - TIMBER STUD

TIMBER FRAME WITH TWO LAYERS GTEK™ FIRE - HORIZONTAL SHEETING

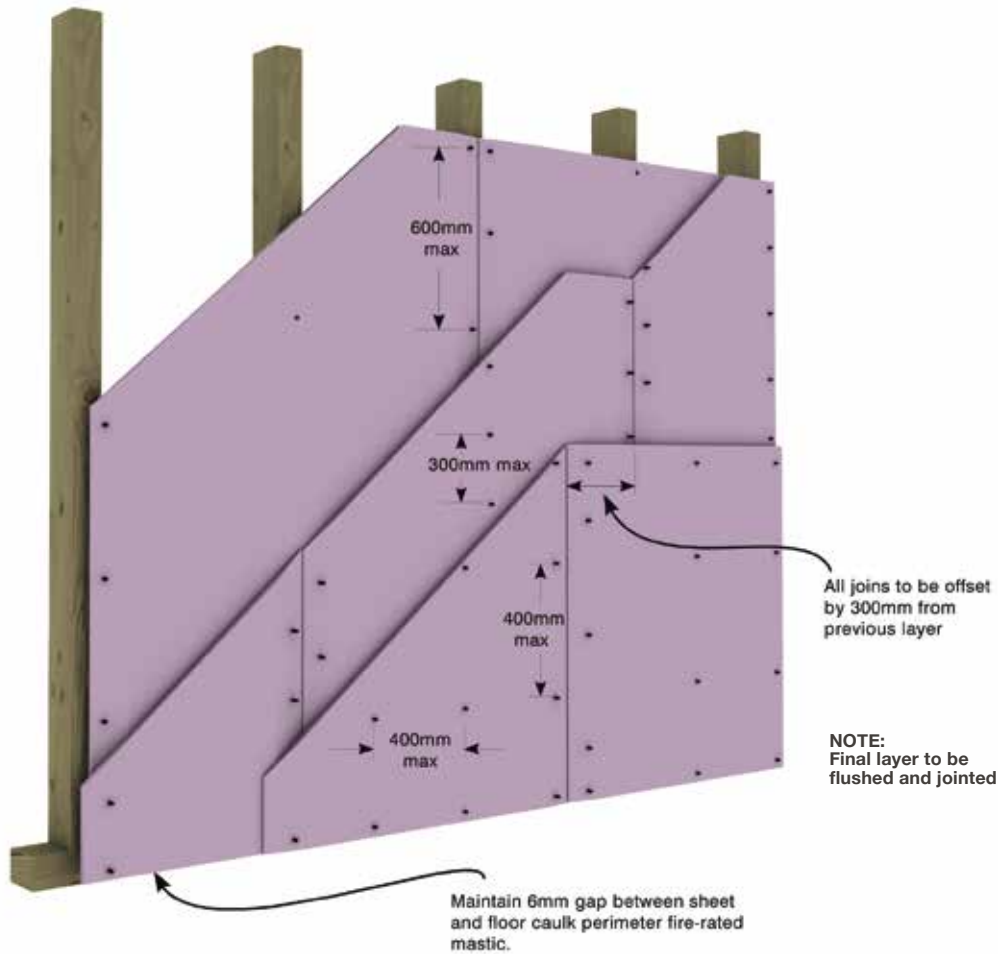


FIXING SPECIFICATIONS FIRST LAYER	
FASTENER SPACING	LOCATION
Nails or Screws 600mm max. centres	Centre of the Board
Nails or Screws 600mm max. centres	Recessed Edges
Nails or Screws 600mm max. centres in staggered pattern	Butt Joints
SECOND LAYER	
2 Nails 50mm apart at 300mm max. centres 1 screw at 200mm max. centres	Centre of the Board
Nails or screws at 300mm max. centres	Recessed Edges
Nails at 150mm max. centres Screws at 200mm max. centres	Butt Joints on noggins
Nails at 150mm max. centres Screws at 300mm max. centres	Corners & Openings

SCREW FIXINGS FOR SOFT WOOD TIMBER FRAMING			SCREW LENGTH	
FRAMING	GTEK™ FIRE THICKNESS	SCREW/NAIL	1ST LAYER	2ND LAYER
Soft Wood Timber	13mm	No 6 Type W	32mm	50mm
	16mm	No 6 Type W	45mm	65mm
	13mm/16mm	2.8 Hot Dip Gal Clout	50mm	65mm

INSTALLATION DETAILS - TIMBER STUD

TIMBER FRAME WITH THREE LAYERS GTEK™ FIRE - VERTICAL SHEETING



**FIXING SPECIFICATIONS  
THREE LAYER HORIZONTAL  
FIRST LAYER**

FASTENER SPACING	LOCATION
600mm max. centres	Centre of the Board
Fasteners at each stud	Recessed Edges
600mm max. centres	Corners & Openings

**SECOND LAYER**

2 nails 50mm apart at 300mm max. centre	Centre of the Board
1 scrow at 200mm max. centres	
Fasteners at each stud	
Nails 300mm max	Recessed Edges
Screws 150mm max centres	Butt Joints on studs

**THIRD LAYER**

Laminating Screws at 400mm max. grid	Centre of the Board
	Recessed Edges
	Corners & Openings
Laminating Screws 400mm max. centres	Butt Joints

**FIXING SPECIFICATIONS THREE LAYER  
VERTICAL-VERTICAL SHEETING (Shown)  
FIRST LAYER**

FASTENER SPACING	LOCATION
600mm max. centres	Centre of the Board
600mm max. centres	Recessed Edges
600mm max. centres	Corners & Openings

**SECOND LAYER**

2 nails 50mm apart at 300mm max. centre	Centre of the Board
1 scrow at 300mm max. centres	
300mm max. centres	Recessed Edges
Laminating Screws 200mm max. centres	Butt Joints
Nail screws 150mm max 300mm max. centres	Corners & Openings

**THIRD LAYER**

Laminating Screws at 400mm max. grid	Centre of the Board
	Recessed Edges
	Corners & Openings
Laminating Screws 200mm max. centres	Butt Joints

**SCREW FIXINGS FOR SOFT WOOD TIMBER FRAMING**

FRAMING	GTEK™ FIRE THICKNESS	SCREW	NAIL	SCREW LENGTH		
				1ST LAYER	2ND LAYER	3RD LAYER
Soft Wood Timber	13mm	No. 6 Type W	2.8x50mm Hot Dipped Gal Clouts or equal	32mm	50mm	50mm
	16mm			45mm	65mm	65mm
	13mm/16mm			50mm	65mm	65mm



TIMBER FRAME EXTERIOR WALL SYSTEM – SINGLE STUD



**TIMBER STUDS AT 600mm MAX CENTRES  
WITH NOGGINS AT 1350mm MAX CENTRES**

Side 1 1 x 16mm GTEK™ Fire & Wet Area  
1 x 7.5mm Duratex™  
Side 2 1 x 10mm GTEK™ Wall

Fire rated from outside only

**GTEK-TE001**

FRL	CAVITY WIDTH mm	90	120	140
	CAVITY INFILL	Rw/Rw+Ctr		
60/60/60	Nil	41/35	42/35	42/36
	9kg - 50mm Glasswool	45/38	46/40	46/41
	30kg - 75mm Glasswool	45/38	46/41	46/41
	<b>WALL THICKNESS mm</b>	<b>123.5</b>	<b>155.5</b>	<b>173.5</b>



**TIMBER STUDS AT 600mm MAX CENTRES  
WITH NOGGINS AT 1350mm MAX CENTRES**

Side 1 2 x 16mm GTEK™ Fire & Wet Area  
1 x 7.5mm Duratex™  
Side 2 1 x 10mm GTEK™ Wall

Fire rated from outside only

**GTEK-TE002**

FRL	CAVITY WIDTH mm	90	120	140
	CAVITY INFILL	Rw/Rw+Ctr		
90/90/90	Nil	45/39	45/39	46/39
	9kg - 50mm Glasswool	48/42	48/44	48/45
	30kg - 75mm Glasswool	48/42	48/45	49/45
	<b>WALL THICKNESS mm</b>	<b>139.5</b>	<b>169.5</b>	<b>189.5</b>



**TIMBER STUDS AT 600mm MAX CENTRES  
WITH NOGGINS AT 1350mm MAX CENTRES**

Side 1 1 x 16mm GTEK™ Fire & Wet Area  
1 x 9mm Duragrid™  
Side 2 1 x 10mm GTEK™ Wall

Fire rated from outside only  
Timber batten can be substituted for steel batten

**GTEK-TE003**

FRL	CAVITY WIDTH mm	90	120	140
	CAVITY INFILL	Rw/Rw+Ctr		
60/60/60	Nil	38/27	41/31	43/34
	9kg - 50mm Glasswool	45/34	47/37	48/39
	30kg - 75mm Glasswool	45/34	47/37	48/39
	<b>WALL THICKNESS mm</b>	<b>125</b>	<b>155</b>	<b>175</b>

TIMBER FRAME EXTERIOR WALL SYSTEM – SINGLE STUD



**TIMBER STUDS AT 600mm MAX CENTRES  
WITH NOGGINS AT 1350mm MAX CENTRES**

Side 1 2 x 16mm GTEK™ Fire & Wet Area  
1 x 9mm Duragrid™  
Side 2 1 x 10mm GTEK™ Wall

Fire rated from outside only  
Timber batten can be substituted for steel batten

**GTEK-TE004**

FRL	CAVITY WIDTH mm	90	120	140
	CAVITY INFILL	Rw/Rw+Ctr		
90/90/90	Nil	42/30	45/35	47/37
	9kg - 50mm Glasswool	48/37	50/40	51/41
	30kg - 75mm Glasswool	48/37	50/40	51/41
	<b>WALL THICKNESS mm</b>	<b>141</b>	<b>171</b>	<b>191</b>



**TIMBER STUDS AT 600mm MAX CENTRES  
WITH NOGGINS AT 1350mm MAX CENTRES**

Side 1 1 x 16mm GTEK™ Fire & Wet Area  
1 x 9mm Duracom™  
Side 2 1 x 10mm GTEK™ Wall

Fire rated from outside only

**GTEK-TE005**

FRL	CAVITY WIDTH mm	90	120	140
	CAVITY INFILL	Rw/Rw+Ctr		
60/60/60	Nil	40/28	43/32	44/34
	9kg - 50mm Glasswool	46/34	48/37	48/38
	30kg - 75mm Glasswool	46/34	48/37	48/38
	<b>WALL THICKNESS mm</b>	<b>125</b>	<b>155</b>	<b>175</b>



**TIMBER STUDS AT 600mm MAX CENTRES  
WITH NOGGINS AT 1350mm MAX CENTRES**

Side 1 2 x 16mm GTEK™ Fire & Wet Area  
1 x 9mm Duracom™  
Side 2 1 x 10mm GTEK™ Wall

Fire rated from outside only

**GTEK-TE006**

FRL	CAVITY WIDTH mm	90	120	140
	CAVITY INFILL	Rw/Rw+Ctr		
90/90/90	Nil	40/28	44/32	45/34
	9kg - 50mm Glasswool	49/34	50/37	51/39
	30kg - 75mm Glasswool	49/34	50/37	51/39
	<b>WALL THICKNESS mm</b>	<b>141</b>	<b>171</b>	<b>191</b>

TIMBER FRAME EXTERIOR WALL SYSTEM – SINGLE STUD



**TIMBER STUDS AT 600mm MAX CENTRES  
WITH NOGGINS AT 1350mm MAX CENTRES**

- Side 1 1 x 16mm GTEK™ Fire & Wet Area  
1 x 14mm Nuline™ Plus
- Side 2 1 x 10mm GTEK™ Wall

Fire rated from outside only

**GTEK-TE007**

FRL	CAVITY WIDTH mm	90	120	140
	CAVITY INFILL	Rw/Rw+Ctr		
60/60/60	Nil	41/30	41/31	44/33
	9kg - 50mm Glasswool	46/34	47/37	48/38
	30kg - 75mm Glasswool	46/34	47/37	48/38
	<b>WALL THICKNESS mm</b>	<b>130</b>	<b>160</b>	<b>180</b>



**TIMBER STUDS AT 600mm MAX CENTRES  
WITH NOGGINS AT 1350mm MAX CENTRES**

- Side 1 2 x 16mm GTEK™ Fire & Wet Area  
1 x 14mm Nuline™ Plus
- Side 2 1 x 10mm GTEK™ Wall

Fire rated from outside only

**GTEK-TE008**

FRL	CAVITY WIDTH mm	90	120	140
	CAVITY INFILL	Rw/Rw+Ctr		
90/90/90	Nil	42/29	44/31	46/33
	9kg - 50mm Glasswool	48/34	50/37	50/38
	30kg - 75mm Glasswool	48/34	50/37	50/38
	<b>WALL THICKNESS mm</b>	<b>146</b>	<b>176</b>	<b>196</b>



**TIMBER STUDS AT 600mm MAX CENTRES  
WITH NOGGINS AT 1350mm MAX CENTRES**

- Side 1 1 x 16mm GTEK™ Fire & Wet Area  
1 x 9mm Durascape™
- Side 2 1 x 10mm GTEK™ Wall

Fire rated from outside only

**GTEK-TE009**

FRL	CAVITY WIDTH mm	90	120	140
	CAVITY INFILL	Rw/Rw+Ctr		
60/60/60	Nil	42/36	43/36	43/37
	9kg - 50mm Glasswool	46/39	46/41	46/41
	30kg - 75mm Glasswool	46/40	46/41	46/42
	<b>WALL THICKNESS mm</b>	<b>125</b>	<b>155</b>	<b>175</b>

TIMBER FRAME EXTERIOR WALL SYSTEM – SINGLE STUD



**TIMBER STUDS AT 600mm MAX CENTRES  
WITH NOGGINS AT 1350mm MAX CENTRES**

Side 1 2 x 16mm GTEK™ Fire & Wet Area  
1 x 9mm Durascape™  
Side 2 1 x 10mm GTEK™ Wall

Fire rated from outside only

**GTEK-TE010**

FRL	CAVITY WIDTH mm	90	120	140
	CAVITY INFILL	Rw/Rw+Ctr		
90/90/90	Nil	45/39	45/39	46/40
	9kg - 50mm Glasswool	48/43	49/44	49/44
	30kg - 75mm Glasswool	48/43	49/45	49/45
	<b>WALL THICKNESS mm</b>	<b>141</b>	<b>171</b>	<b>191</b>



**TIMBER STUDS AT 600mm MAX CENTRES  
WITH NOGGINS AT 1350mm MAX CENTRES**

Side 1 1 x 16mm GTEK™ Fire & Wet Area  
1 x 9mm Duragroove™  
Side 2 1 x 10mm GTEK™ Wall

Fire rated from outside only

**GTEK-TE011**

FRL	CAVITY WIDTH mm	90	120	140
	CAVITY INFILL	Rw/Rw+Ctr		
60/60/60	Nil	42/36	43/36	43/37
	9kg - 50mm Glasswool	46/39	46/41	46/41
	30kg - 75mm Glasswool	46/39	46/41	46/42
	<b>WALL THICKNESS mm</b>	<b>125</b>	<b>155</b>	<b>175</b>



**TIMBER STUDS AT 600mm MAX CENTRES  
WITH NOGGINS AT 1350mm MAX CENTRES**

Side 1 2 x 16mm GTEK™ Fire & Wet Area  
1 x 9mm Duragroove™  
Side 2 1 x 10mm GTEK™ Wall

Fire rated from outside only

**GTEK-TE012**

FRL	CAVITY WIDTH mm	90	120	140
	CAVITY INFILL	Rw/Rw+Ctr		
90/90/90	Nil	45/39	45/39	46/40
	9kg - 50mm Glasswool	48/43	49/44	49/44
	30kg - 75mm Glasswool	48/43	49/45	49/44
	<b>WALL THICKNESS mm</b>	<b>141</b>	<b>171</b>	<b>191</b>

TIMBER FRAME EXTERIOR WALL SYSTEM – SINGLE STUD



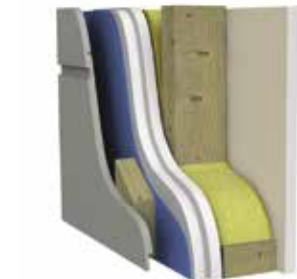
OUTSIDE ONLY

**TIMBER STUDS AT 600mm MAX CENTRES  
WITH NOGGINS AT 1350mm MAX CENTRES**

- Side 1 1 x 12mm Stratum™/Stratum Duo™/Stratum™ Trio  
1 x 16mm GTEK™ Fire & Wet Area
- Side 2 1 x 10mm GTEK™ Wall

**GTEK-TE013**

FRL	CAVITY WIDTH mm	90	120	140
	CAVITY INFILL	Rw/Rw+Ctr		
60/60/60	Nil	39/29	41/31	43/32
	9kg - 50mm Glasswool	45/33	47/36	47/37
	30kg - 75mm Glasswool	45/33	47/36	47/37
	<b>WALL THICKNESS mm</b>	<b>163</b>	<b>193</b>	<b>213</b>



OUTSIDE ONLY

**TIMBER STUDS AT 600mm MAX CENTRES  
WITH NOGGINS AT 1350mm MAX CENTRES**

- Side 1 1 x 12mm Stratum™/Stratum Duo™/Stratum™ Trio  
2 x 16mm GTEK™ Fire & Wet Area
- Side 2 1 x 10mm GTEK™ Wall

**GTEK-TE014**

FRL	CAVITY WIDTH mm	90	120	140
	CAVITY INFILL	Rw/Rw+Ctr		
90/90/90	Nil	41/30	43/32	45/33
	9kg - 50mm Glasswool	48/34	49/37	49/39
	30kg - 75mm Glasswool	48/34	49/37	49/39
	<b>WALL THICKNESS mm</b>	<b>179</b>	<b>209</b>	<b>229</b>



OUTSIDE ONLY

**TIMBER STUDS AT 600mm MAX CENTRES  
WITH NOGGINS AT 1350mm MAX CENTRES**

- Side 1 1 x 10mm Stratum™ Contour  
1 x 16mm GTEK™ Fire & Wet Area
- Side 2 1 x 10mm GTEK™ Wall

**GTEK-TE015**

FRL	CAVITY WIDTH mm	90	120	140
	CAVITY INFILL	Rw/Rw+Ctr		
60/60/60	Nil	38/29	40/30	41/31
	9kg - 50mm Glasswool	44/32	46/35	47/36
	30kg - 75mm Glasswool	44/32	46/35	47/36
	<b>WALL THICKNESS mm</b>	<b>161</b>	<b>191</b>	<b>211</b>

TIMBER FRAME EXTERIOR WALL SYSTEM – SINGLE STUD



OUTSIDE ONLY

TIMBER STUDS AT 600mm MAX CENTRES  
WITH NOGGINS AT 1350mm MAX CENTRES

- Side 1 1 x 10mm Stratum™ Contour  
2 x 16mm GTEK™ Fire & Wet Area
- Side 2 1 x 10mm GTEK™ Wall

GTEK-TE016

FRL	CAVITY WIDTH mm	90	120	140
	CAVITY INFILL	Rw/Rw+Ctr		
90/90/90	Nil	40/29	42/31	44/33
	9kg - 50mm Glasswool	47/34	49/37	49/38
	30kg - 75mm Glasswool	47/34	49/37	49/38
	<b>WALL THICKNESS mm</b>	<b>177</b>	<b>207</b>	<b>227</b>



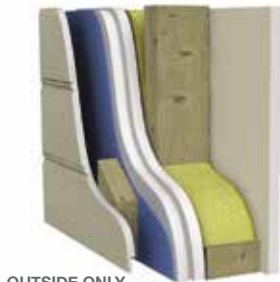
OUTSIDE ONLY

TIMBER STUDS AT 600mm MAX CENTRES  
WITH NOGGINS AT 1350mm MAX CENTRES

- Side 1 1 x 10mm Stratum™ Era  
1 x 16mm GTEK™ Fire & Wet Area
- Side 2 1 x 10mm GTEK™ Wall

GTEK-TE017

FRL	CAVITY WIDTH mm	90	120	140
	CAVITY INFILL	Rw/Rw+Ctr		
60/60/60	Nil	38/28	40/28	41/31
	9kg - 50mm Glasswool	44/32	46/35	46/36
	30kg - 75mm Glasswool	44/32	46/35	46/36
	<b>WALL THICKNESS mm</b>	<b>161</b>	<b>191</b>	<b>211</b>



OUTSIDE ONLY

TIMBER STUDS AT 600mm MAX CENTRES  
WITH NOGGINS AT 1350mm MAX CENTRES

- Side 1 1 x 10mm Stratum™ Era  
2 x 16mm GTEK™ Fire & Wet Area
- Side 2 1 x 10mm GTEK™ Wall

GTEK-TE018

FRL	CAVITY WIDTH mm	90	120	140
	CAVITY INFILL	Rw/Rw+Ctr		
90/90/90	Nil	40/29	42/31	44/33
	9kg - 50mm Glasswool	47/34	48/36	49/38
	30kg - 75mm Glasswool	47/34	48/36	49/38
	<b>WALL THICKNESS mm</b>	<b>177</b>	<b>207</b>	<b>227</b>

STEEL FRAME EXTERIOR WALL SYSTEM – SINGLE STUD



STEEL STUDS AT 600mm MAX CENTRES

- Side 1 1 x 16mm GTEK™ Fire & Wet Area
- Side 2 1 x 7.5mm Duratex™  
1 x 16mm GTEK™ Fire

GTEK-SE001

FRL	CAVITY WIDTH mm	64	76	92	150
	CAVITY INFILL	Rw/Rw+Ctr			
60/60/60	Nil	42/36	42/35	43/36	45/37
	9kg - 50mm Glasswool	49/41	50/43	51/44	52/47
	30kg - 75mm Glasswool		51/43	51/44	52/47
	<b>WALL THICKNESS mm</b>	<b>103.5</b>	<b>115.5</b>	<b>131.5</b>	<b>189.5</b>



STEEL STUDS AT 600mm MAX CENTRES

- Side 1 2 x 16mm GTEK™ Fire & Wet Area
- Side 2 1 x 7.5mm Duratex™  
2 x 16mm GTEK™ Fire

GTEK-SE002

FRL	CAVITY WIDTH mm	64	76	92	150
	CAVITY INFILL	Rw/Rw+Ctr			
90/90/90	Nil	48/41	48/41	49/42	52/44
	9kg - 50mm Glasswool	56/50	57/51	57/51	57/52
	30kg - 75mm Glasswool		57/51	57/51	57/52
	<b>WALL THICKNESS mm</b>	<b>135.5</b>	<b>147.5</b>	<b>163.5</b>	<b>221.5</b>



STEEL STUDS AT 600mm MAX CENTRES

- Side 1 1 x 16mm GTEK™ Fire & Wet Area
- Side 2 1 x 9mm Duragrid™  
1 x 16mm GTEK™ Fire

Timber batten can be substituted for steel batten

GTEK-SE003

FRL	CAVITY WIDTH mm	64	76	92	150
	CAVITY INFILL	Rw/Rw+Ctr			
60/60/60	Nil	42/30	44/33	46/36	50/42
	9kg - 50mm Glasswool	49/37	51/40	52/42	55/46
	30kg - 75mm Glasswool		51/40	52/42	55/46
	<b>WALL THICKNESS mm</b>	<b>105</b>	<b>117</b>	<b>133</b>	<b>191</b>

\* Acoustic values for steel frame exterior wall systems are based on frame of 0.55mm BMT

\* Batten: 70 x 19 Durabatten  
35 x 70 x 0.75 Durabatten

STEEL FRAME EXTERIOR WALL SYSTEM – SINGLE STUD



**STEEL STUDS AT 600mm MAX CENTRES**

Side 1 2 x 16mm GTEK™ Fire & Wet Area  
 Side 2 1 x 9mm Duragrid™  
 2 x 16mm GTEK™ Fire

Timber batten can be substituted for steel batten

**GTEK-SE004**

FRL	CAVITY WIDTH mm	64	76	92	150
	CAVITY INFILL	Rw/Rw+Ctr			
90/90/90	Nil	50/40	51/42	52/43	54/46
	9kg - 50mm Glasswool	57/46	58/48	59/49	60/53
	30kg - 75mm Glasswool		58/48	59/49	60/53
	<b>WALL THICKNESS mm</b>	<b>137</b>	<b>149</b>	<b>165</b>	<b>223</b>



**STEEL STUDS AT 600mm MAX CENTRES**

Side 1 1 x 16mm GTEK™ Fire & Wet Area  
 Side 2 1 x 9mm Duracom™  
 1 x 16mm GTEK™ Fire

**GTEK-SE005**

FRL	CAVITY WIDTH mm	64	76	92	150
	CAVITY INFILL	Rw/Rw+Ctr			
60/60/60	Nil	44/33	45/35	47/37	52/42
	9kg - 50mm Glasswool	49/37	52/40	53/42	56/46
	30kg - 75mm Glasswool		52/40	53/42	56/46
	<b>WALL THICKNESS mm</b>	<b>105</b>	<b>117</b>	<b>133</b>	<b>191</b>



**STEEL STUDS AT 600mm MAX CENTRES**

Side 1 2 x 16mm GTEK™ Fire & Wet Area  
 Side 2 1 x 9mm Duracom™  
 2 x 16mm GTEK™ Fire

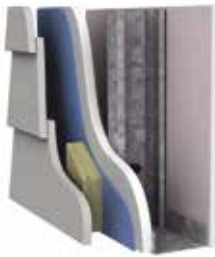
**GTEK-SE006**

FRL	CAVITY WIDTH mm	64	76	92	150
	CAVITY INFILL	Rw/Rw+Ctr			
90/90/90	Nil	51/41	53/42	54/44	56/46
	9kg - 50mm Glasswool	57/45	58/46	59/48	59/51
	30kg - 75mm Glasswool		58/46	59/48	59/51
	<b>WALL THICKNESS mm</b>	<b>137</b>	<b>149</b>	<b>165</b>	<b>223</b>

\* Acoustic values for steel frame exterior wall systems are based on frame of 0.55mm BMT



STEEL FRAME EXTERIOR WALL SYSTEM – SINGLE STUD



**STEEL STUDS AT 600mm MAX CENTRES**

- Side 1 1 x 16mm GTEK™ Fire & Wet Area
- Side 2 1 x 14mm Nuline™ Plus
- 1 x 16mm GTEK™ Fire

**GTEK-SE007**

FRL	CAVITY WIDTH mm	64	76	92	150
	CAVITY INFILL	Rw/Rw+Ctr			
60/60/60	Nil	45/35	47/36	46/36	50/40
	9kg - 50mm Glasswool	50/38	51/40	52/41	54/45
	30kg - 75mm Glasswool		51/40	52/41	54/45
	<b>WALL THICKNESS mm</b>	<b>110</b>	<b>122</b>	<b>138</b>	<b>196</b>



**STEEL STUDS AT 600mm MAX CENTRES**

- Side 1 2 x 16mm GTEK™ Fire & Wet Area
- Side 2 1 x 14mm Nuline™ Plus
- 2 x 16mm GTEK™ Fire

**GTEK-SE008**

FRL	CAVITY WIDTH mm	64	76	92	150
	CAVITY INFILL	Rw/Rw+Ctr			
90/90/90	Nil	52/40	51/39	53/41	56/45
	9kg - 50mm Glasswool	57/44	58/45	58/46	59/50
	30kg - 75mm Glasswool		58/44	58/46	59/50
	<b>WALL THICKNESS mm</b>	<b>142</b>	<b>154</b>	<b>170</b>	<b>228</b>



**STEEL STUDS AT 600mm MAX CENTRES**

- Side 1 1 x 16mm GTEK™ Fire & Wet Area
- Side 2 1 x 9mm Durascape™
- 1 x 16mm GTEK™ Fire

**GTEK-SE009**

FRL	CAVITY WIDTH mm	64	76	92	150
	CAVITY INFILL	Rw/Rw+Ctr			
60/60/60	Nil	42/36	42/36	43/36	45/38
	9kg - 50mm Glasswool	50/42	51/44	52/44	53/47
	30kg - 75mm Glasswool		51/44	52/45	53/48
	<b>WALL THICKNESS mm</b>	<b>105</b>	<b>117</b>	<b>133</b>	<b>191</b>

\* Acoustic values for steel frame exterior wall systems are based on frame of 0.55mm BMT

\* Nuline – 70 x 19 Durabatten, 35 x 70 x 0.75 Steel Light Weight Top Hat

STEEL FRAME EXTERIOR WALL SYSTEM – SINGLE STUD



**STEEL STUDS AT 600mm MAX CENTRES**

Side 1 2 x 16mm GTEK™ Fire & Wet Area  
 Side 2 1 x 9mm Durascape™  
 2 x 16mm GTEK™ Fire

**GTEK-SE010**

FRL	CAVITY WIDTH mm	64	76	92	150
	CAVITY INFILL	Rw/Rw+Ctr			
90/90/90	Nil	48/41	49/42	50/43	52/44
	9kg - 50mm Glasswool	57/50	57/51	57/51	58/53
	30kg - 75mm Glasswool		57/51	58/52	58/53
	<b>WALL THICKNESS mm</b>	<b>137</b>	<b>149</b>	<b>165</b>	<b>223</b>



**STEEL STUDS AT 600mm MAX CENTRES**

Side 1 1 x 16mm GTEK™ Fire & Wet Area  
 Side 2 1 x 9mm Duragroove™  
 1 x 16mm GTEK™ Fire

**GTEK-SE011**

FRL	CAVITY WIDTH mm	64	76	92	150
	CAVITY INFILL	Rw/Rw+Ctr			
60/60/60	Nil	42/36	42/36	43/36	45/38
	9kg - 50mm Glasswool	50/42	51/44	52/44	53/47
	30kg - 75mm Glasswool		51/44	52/45	53/48
	<b>WALL THICKNESS mm</b>	<b>105</b>	<b>117</b>	<b>133</b>	<b>191</b>



**STEEL STUDS AT 600mm MAX CENTRES**

Side 1 2 x 16mm GTEK™ Fire & Wet Area  
 Side 2 1 x 9mm Duragroove™  
 2 x 16mm GTEK™ Fire

**GTEK-SE012**

FRL	CAVITY WIDTH mm	64	76	92	150
	CAVITY INFILL	Rw/Rw+Ctr			
90/90/90	Nil	48/41	49/42	50/43	52/44
	9kg - 50mm Glasswool	57/50	57/51	57/51	58/53
	30kg - 75mm Glasswool		57/51	58/52	58/53
	<b>WALL THICKNESS mm</b>	<b>137</b>	<b>149</b>	<b>165</b>	<b>223</b>

\* Acoustic values for steel frame exterior wall systems are based on frame of 0.55mm BMT

STEEL FRAME EXTERIOR WALL SYSTEM – SINGLE STUD



**STEEL STUDS AT 600mm MAX CENTRES**

- Side 1 1 x 16mm GTEK™ Fire & Wet Area  
1 x 12mm Stratum™/Stratum™ Duo/Stratum™ Trio  
35mm batten
- Side 2 1 x 16mm GTEK™ Fire

**GTEK-SE013**

FRL	CAVITY WIDTH mm	64	76	92	150
	CAVITY INFILL	Rw/Rw+Ctr			
60/60/60	Nil	42/32	44/34	46/36	50/42
	9kg - 50mm Glasswool	49/38	51/41	51/42	54/45
	30kg - 75mm Glasswool	49/38	51/41	51/42	54/45
	<b>WALL THICKNESS mm</b>	<b>143</b>	<b>155</b>	<b>171</b>	<b>229</b>



**STEEL STUDS AT 600mm MAX CENTRES**

- Side 1 2 x 16mm GTEK™ Fire & Wet Area  
1 x 12mm Stratum™/Stratum™ Duo/Stratum™ Trio  
35mm batten
- Side 2 2 x 16mm GTEK™ Fire

**GTEK-SE014**

FRL	CAVITY WIDTH mm	64	76	92	150
	CAVITY INFILL	Rw/Rw+Ctr			
90/90/90	Nil	50/40	51/41	52/43	54/46
	9kg - 50mm Glasswool	56/47	56/48	56/49	57/51
	30kg - 75mm Glasswool	56/47	56/48	56/49	57/51
	<b>WALL THICKNESS mm</b>	<b>175</b>	<b>187</b>	<b>203</b>	<b>261</b>



**STEEL STUDS AT 600mm MAX CENTRES**

- Side 1 1 x 16mm GTEK™ Fire & Wet Area  
1 x 10mm Stratum™ Contour  
35mm batten
- Side 2 1 x 16mm GTEK™ Fire

**GTEK-SE015**

FRL	CAVITY WIDTH mm	64	76	92	150
	CAVITY INFILL	Rw/Rw+Ctr			
60/60/60	Nil	42/32	42/32	45/36	48/40
	9kg - 50mm Glasswool	48/37	50/40	51/41	52/44
	30kg - 75mm Glasswool	48/37	50/40	51/41	52/44
	<b>WALL THICKNESS mm</b>	<b>141</b>	<b>153</b>	<b>169</b>	<b>227</b>

\* Acoustic values for steel frame exterior wall systems are based on frame of 0.55mm BMT

STEEL FRAME EXTERIOR WALL SYSTEM – SINGLE STUD



**STEEL STUDS AT 600mm MAX CENTRES**

Side 1 2 x 16mm GTEK™ Fire & Wet Area  
 1 x 10mm Stratum™ Contour  
 Side 2 2 x 16mm GTEK™ Fire

**GTEK-SE016**

FRL	CAVITY WIDTH mm	64	76	92	150
	CAVITY INFILL	Rw/Rw+Ctr			
90/90/90	Nil	50/39	51/41	52/42	54/46
	9kg - 50mm Glasswool	56/46	56/48	56/49	57/51
	30kg - 75mm Glasswool	56/46	56/48	56/49	57/51
	<b>WALL THICKNESS mm</b>	<b>173</b>	<b>185</b>	<b>201</b>	<b>259</b>



**STEEL STUDS AT 600mm MAX CENTRES**

Side 1 1 x 16mm GTEK™ Fire & Wet Area  
 1 x 10mm Stratum™ Era  
 Side 2 1 x 16mm GTEK™ Fire

**GTEK-SE017**

FRL	CAVITY WIDTH mm	64	76	92	150
	CAVITY INFILL	Rw/Rw+Ctr			
60/60/60	Nil	42/32	42/32	45/35	48/39
	9kg - 50mm Glasswool	48/37	50/39	51/41	52/44
	30kg - 75mm Glasswool	48/37	50/39	51/41	52/44
	<b>WALL THICKNESS mm</b>	<b>141</b>	<b>153</b>	<b>169</b>	<b>227</b>



**STEEL STUDS AT 600mm MAX CENTRES**

Side 1 2 x 16mm GTEK™ Fire & Wet Area  
 1 x 10mm Stratum™ Era  
 Side 2 2 x 16mm GTEK™ Fire

**GTEK-SE018**

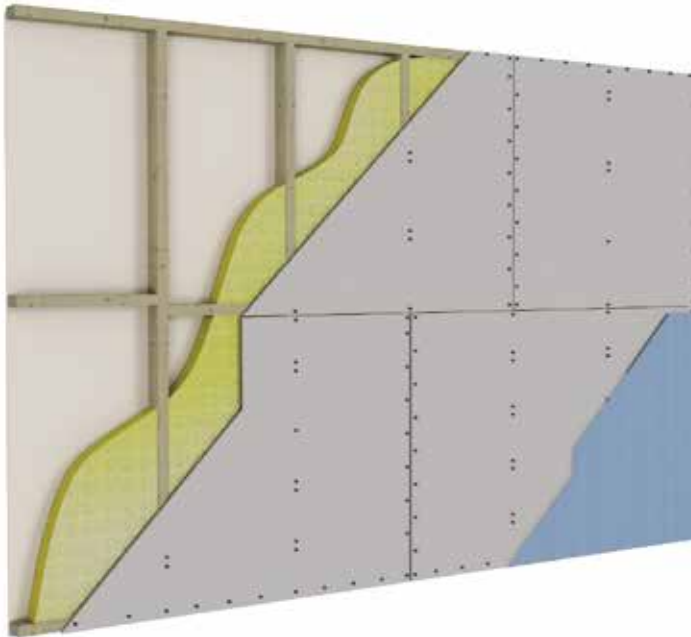
FRL	CAVITY WIDTH mm	64	76	92	150
	CAVITY INFILL	Rw/Rw+Ctr			
90/90/90	Nil	49/39	51/41	52/42	53/45
	9kg - 50mm Glasswool	56/46	56/47	56/49	57/51
	30kg - 75mm Glasswool	56/46	56/47	56/49	57/51
	<b>WALL THICKNESS mm</b>	<b>173</b>	<b>185</b>	<b>201</b>	<b>259</b>

\* Acoustic values for steel frame exterior wall systems are based on frame of 0.55mm BMT

\* Batten: Duragrid and other cladding.  
 Durabatten: Hardwood 70 x 19  
 35 x 70 x 0.75 Lightweight Steel Top Hat

INSTALLATION DETAILS - EXTERIOR WALLS

TIMBER FRAME WITH ONE LAYER GTEK™ FIRE & WET AREA 60/60/60 BOUNDARY WALL

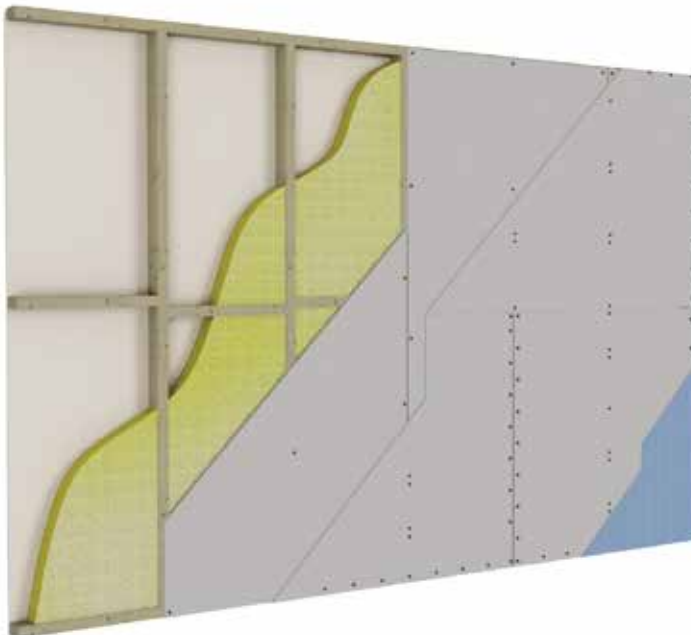


FIXING SPECIFICATIONS	
1 screw at 600mm max. centres	Centre of the Board
At Each Stud	Recessed Edges
Screws at 300mm max. centres	Butt Joints
Screws at 300mm max. centres	Corners & Openings

**NOTE:**  
Final layer to be flushed and jointed

SCREW FIXINGS FOR SOFT WOOD TIMBER FRAMING			SCREW LENGTH
FRAMING	GTEK™ FIRE THICKNESS	SCREW TYPE	1ST LAYER
Soft Wood Timber	16mm	No 6 Type W	45mm

TIMBER FRAME WITH TWO LAYERS GTEK™ FIRE & WET AREA 90/90/90 BOUNDARY WALL



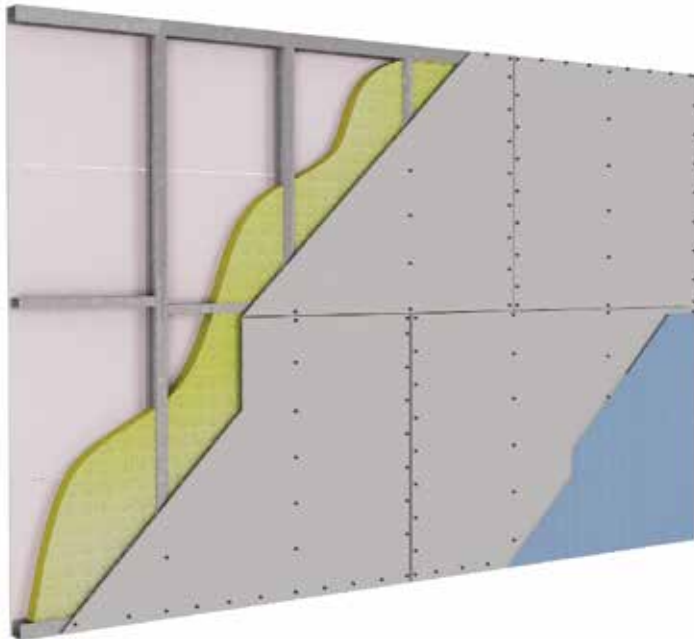
FIXING SPECIFICATIONS	
FIRST LAYER	
FASTENER SPACING	LOCATION
Screws 600mm max. centres	Centre of the Board
Screws 300mm max. centres	Recessed Edges
Screws 300mm max. centres in staggered pattern	Butt Joints
SECOND LAYER	
1 screw at 600mm max. centres	Centre of the Board
At Each Stud	Recessed Edges
Screws at 300mm max. centres	Butt Joints
Screws at 300mm max. centres	Corners & Openings

**NOTE:**  
Final layer to be flushed and jointed

SCREW FIXINGS FOR SOFT WOOD TIMBER FRAMING			SCREW LENGTH
FRAMING	GTEK™ FIRE THICKNESS	SCREW TYPE	1ST LAYER
Soft Wood Timber	16mm	No 6 Type W	45mm

INSTALLATION DETAILS – EXTERIOR WALLS

STEEL FRAME WITH ONE LAYER GTEK™ FIRE & WET AREA 60/60/60 BOUNDARY WALL

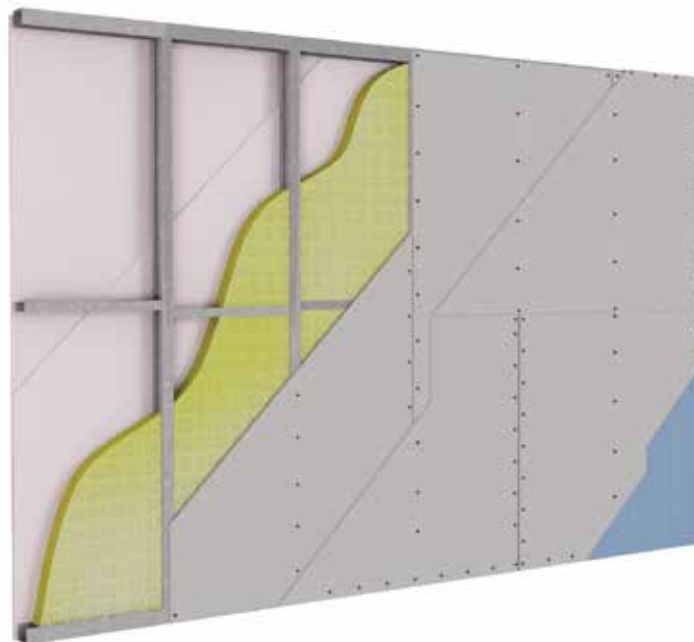


FIXING SPECIFICATIONS	
FASTENER SPACING	LOCATION
200mm max. centres	Centre of the Board
At Each Stud	Recessed Edges
100mm max. centres	Butt Joints
200mm max. centres	Corners & Openings

SCREW FIXINGS FOR LIGHTWEIGHT STEEL FRAMING			SCREW LENGTH
FRAMING	GTEK™ FIRE THICKNESS	SCREW TYPE	1ST LAYER
Lightweight Steel up to 0.8mm	16mm	No 6 Type S Needle Point	30mm
Lightweight Steel 0.8mm to 1.6mm	16mm	No 6 Type D Drill Point	32mm

**NOTE:**  
Final layer to be flushed and jointed

STEEL FRAME WITH TWO LAYERS GTEK™ FIRE & WET AREA 90/90/90 BOUNDARY WALL



FIXING SPECIFICATIONS FIRST LAYER	
FASTENER SPACING	LOCATION
200mm max. centres staggered	Centre of the Board
200mm max. centres staggered	Recessed Edges
100mm max. centres staggered	Butt Joints
SECOND LAYER	
200mm max. centres	Centre of the Board
At Each Stud	Recessed Edges
100mm max. centres	Butt Joints
200mm max. centres	Corners & Openings

SCREW FIXINGS FOR LIGHTWEIGHT STEEL FRAMING			SCREW LENGTH	
FRAMING	GTEK™ FIRE THICKNESS	SCREW TYPE	1ST LAYER	2ND LAYER
Lightweight Steel up to 0.8mm	16mm	No 6 Type S Needle Point	30mm	45mm
Lightweight Steel 0.8mm to 1.6mm	16mm	No 6 Type D Drill Point	32mm	45mm

**NOTE:**  
Final layer to be flushed and jointed

FLOOR/CEILING – TIMBER OR STEEL JOISTS



19mm TONGUE & GROOVE PARTICLEBOARD FLOORING  
OR BGC DURAFLOOR™ – MIN CAVITY DEPTH OF 190mm  
Ceiling Lining 1 x 13mm GTEK™ Wall

GTEK-C001

FRL	CAVITY INFILL	Rw/Rw+Ctr
		Nil
-/-/-	9kg - 50mm Glasswool	40/36
	30kg - 75mm Glasswool	38/34



19mm TONGUE & GROOVE PARTICLEBOARD FLOORING  
OR BGC DURAFLOOR™ – MIN CAVITY DEPTH OF 190mm  
Ceiling Lining 2 x 13mm GTEK™ Wall

GTEK-C002

FRL	CAVITY INFILL	Rw/Rw+Ctr
		Nil
-/-/-	9kg - 50mm Glasswool	42/39
	30kg - 75mm Glasswool	42/39



19mm TONGUE & GROOVE PARTICLEBOARD FLOORING  
OR BGC DURAFLOOR™ – MIN CAVITY DEPTH OF 190mm  
Ceiling Lining 1 x 10mm GTEK™ Ceiling

GTEK-C003

FRL	CAVITY INFILL	Rw/Rw+Ctr
		Nil
-/-/-	9kg - 50mm Glasswool	39/35
	30kg - 75mm Glasswool	39/35

FLOOR/CEILING – TIMBER OR STEEL JOISTS



19mm TONGUE & GROOVE PARTICLEBOARD FLOORING  
OR BGC DURAFLOOR™ – MIN CAVITY DEPTH OF 190mm  
Ceiling Lining 2 x 10mm GTEK™ Sound

GTEK-C004

FRL	CAVITY INFILL	Rw/Rw+Ctr
		Nil
-/-/-	9kg - 50mm Glasswool	42/39
	30kg - 75mm Glasswool	42/39



19mm TONGUE & GROOVE PARTICLEBOARD FLOORING  
OR BGC DURAFLOOR™ – MIN CAVITY DEPTH OF 190mm  
Ceiling Lining 1 x 13mm GTEK™ Fire (against frame)  
1 x 16mm GTEK™ Fire

GTEK-C005

FRL	CAVITY INFILL	Rw/Rw+Ctr
		Nil
90/90/90	9kg - 50mm Glasswool	44/41
RISF 60	30kg - 75mm Glasswool	44/41



19mm TONGUE & GROOVE PARTICLEBOARD FLOORING  
OR BGC DURAFLOOR™ – MIN CAVITY DEPTH OF 190mm  
Ceiling Lining 1 x 16mm GTEK™ Fire

GTEK-C018

FRL	CAVITY INFILL	Rw/Rw+Ctr
		Nil
30/30/30	9kg - 50mm Glasswool	40/38
	30kg - 75mm Glasswool	40/38



FLOOR/CEILING – TIMBER OR STEEL JOISTS



19mm TONGUE & GROOVE PARTICLEBOARD FLOORING  
OR BGC DURAFLOOR™ – MIN CAVITY DEPTH OF 190mm  
Ceiling Lining 2 x 16mm GTEK™ Fire

GTEK-C006

FRL	CAVITY INFILL	Rw/Rw+Ctr
	Nil	43/38
90/90/90	9kg - 50mm Glasswool	44/41
RISF 60	30kg - 75mm Glasswool	44/41



19mm TONGUE & GROOVE PARTICLEBOARD FLOORING  
OR BGC DURAFLOOR™ – MIN CAVITY DEPTH OF 190mm  
Ceiling Lining 3 x 16mm GTEK™ Fire

GTEK-C007

FRL	CAVITY INFILL	Rw/Rw+Ctr
	Nil	45/40
120/120/120	9kg - 50mm Glasswool	46/44
RISF 120	30kg - 75mm Glasswool	46/44

FLOOR/CEILING – TIMBER OR STEEL JOISTS WITH FURRING CHANNELS



19mm TONGUE & GROOVE PARTICLEBOARD FLOORING  
OR BGC DURAFLOOR™ WITH FURRING CHANNELS  
MIN CAVITY DEPTH OF 206mm  
Ceiling Lining 1 x 10mm GTEK™ Ceiling

GTEK-C010

FRL	CAVITY INFILL	Rw/Rw+Ctr
		Nil
-/-/-	9kg - 50mm Glasswool	42/38
	30kg - 75mm Glasswool	42/38



19mm TONGUE & GROOVE PARTICLEBOARD FLOORING  
OR BGC DURAFLOOR™ WITH FURRING CHANNELS  
MIN CAVITY DEPTH OF 206mm  
Ceiling Lining 1 x 13mm GTEK™ Wall

GTEK-C011

FRL	CAVITY INFILL	Rw/Rw+Ctr
		Nil
-/-/-	9kg - 50mm Glasswool	43/39
	30kg - 75mm Glasswool	43/39



19mm TONGUE & GROOVE PARTICLEBOARD FLOORING  
OR BGC DURAFLOOR™ WITH FURRING CHANNELS  
MIN CAVITY DEPTH OF 206mm  
Ceiling Lining 1 x 6mm BGC Duraliner™ Plus  
(furring channel at 450mm max centres)

GTEK-C012

FRL	CAVITY INFILL	Rw/Rw+Ctr
		Nil
-/-/-	9kg - 50mm Glasswool	43/39
	30kg - 75mm Glasswool	43/39

FLOOR/CEILING – TIMBER OR STEEL JOISTS WITH FURRING CHANNELS



19mm TONGUE & GROOVE PARTICLEBOARD FLOORING  
OR BGC DURAFLOOR™ WITH FURRING CHANNELS  
MIN CAVITY DEPTH OF 206mm  
Ceiling Lining 1 x 9mm BGC Duraliner™ Plus

GTEK-C013

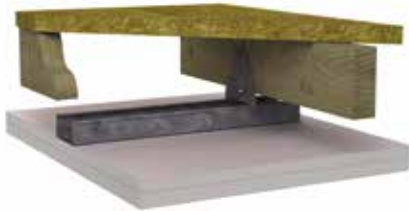
FRL	CAVITY INFILL	Rw/Rw+Ctr
		Nil
-/-/-	9kg - 50mm Glasswool	45/41
	30kg - 75mm Glasswool	45/41



19mm TONGUE & GROOVE PARTICLEBOARD FLOORING  
OR BGC DURAFLOOR™ WITH FURRING CHANNELS  
MIN CAVITY DEPTH OF 206mm  
Ceiling Lining 2 x 13mm GTEK™ Fire

GTEK-C014

FRL	CAVITY INFILL	Rw/Rw+Ctr
		Nil
60/60/60	9kg - 50mm Glasswool	46/43
	30kg - 75mm Glasswool	46/43

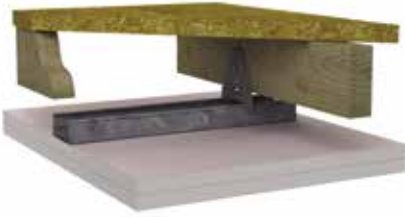


19mm TONGUE & GROOVE PARTICLEBOARD FLOORING  
OR BGC DURAFLOOR™ WITH FURRING CHANNELS  
MIN CAVITY DEPTH OF 206mm  
Ceiling Lining 1 x 13mm GTEK™ Fire (against frame)  
1 x 16mm GTEK™ Fire

GTEK-C015

FRL	CAVITY INFILL	Rw/Rw+Ctr
		Nil
90/90/90	9kg - 50mm Glasswool	47/44
RISF 60	30kg - 75mm Glasswool	47/44

FLOOR/CEILING – TIMBER OR STEEL JOISTS WITH FURRING CHANNELS



19mm TONGUE & GROOVE PARTICLEBOARD FLOORING  
OR BGC DURAFLOOR™ WITH FURRING CHANNELS  
MIN CAVITY DEPTH OF 206mm  
Ceiling Lining 2 x 16mm GTEK™ Fire

GTEK-C016

FRL	CAVITY INFILL	Rw/Rw+Ctr
		Nil
90/90/90	9kg - 50mm Glasswool	47/44
RISF 60	30kg - 75mm Glasswool	47/44

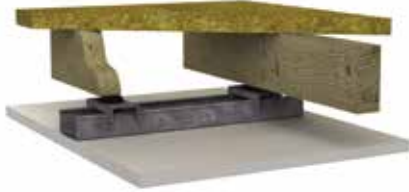


19mm TONGUE & GROOVE PARTICLEBOARD FLOORING  
OR BGC DURAFLOOR™ WITH FURRING CHANNELS  
MIN CAVITY DEPTH OF 206mm  
Ceiling Lining 3 x 16mm GTEK™ Fire

GTEK-C017

FRL	CAVITY INFILL	Rw/Rw+Ctr
		Nil
120/120/120	9kg - 50mm Glasswool	49/47
RISF 120	30kg - 75mm Glasswool	49/47

FLOOR/CEILING – TIMBER OR STEEL JOISTS WITH FURRING CHANNELS AND ACOUSTIC RESILIENT MOUNTS



19mm TONGUE & GROOVE PARTICLEBOARD FLOORING OR BGC DURAFLOOR™ WITH FURRING CHANNELS AND ACOUSTIC RESILIENT MOUNTS - MIN CAVITY DEPTH OF 232mm  
Ceiling Lining 1 x 13mm GTEK™ Wall

GTEK-C020

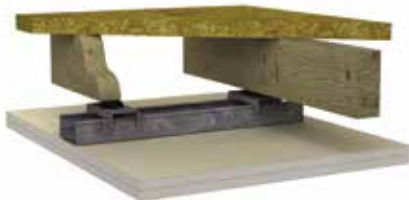
FRL	CAVITY INFILL	Rw/Rw+Ctr
	Nil	42/34
-/-/-	9kg - 50mm Glasswool	49/42
	30kg - 75mm Glasswool	50/43



19mm TONGUE & GROOVE PARTICLEBOARD FLOORING OR BGC DURAFLOOR™ WITH FURRING CHANNELS AND ACOUSTIC RESILIENT MOUNTS - MIN CAVITY DEPTH OF 232mm  
Ceiling Lining 1 x 10mm GTEK™ Sound

GTEK-C021

FRL	CAVITY INFILL	Rw/Rw+Ctr
	Nil	42/34
-/-/-	9kg - 50mm Glasswool	49/42
	30kg - 75mm Glasswool	50/43

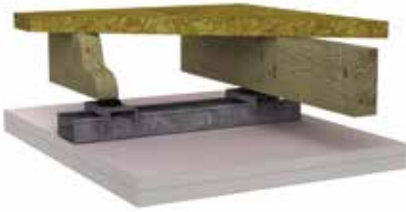


19mm TONGUE & GROOVE PARTICLEBOARD FLOORING OR BGC DURAFLOOR™ WITH FURRING CHANNELS AND ACOUSTIC RESILIENT MOUNTS - MIN CAVITY DEPTH OF 232mm  
Ceiling Lining 2 x 10mm GTEK™ Sound

GTEK-C022

FRL	CAVITY INFILL	Rw/Rw+Ctr
	Nil	47/38
-/-/-	9kg - 50mm Glasswool	54/48
	30kg - 75mm Glasswool	55/49

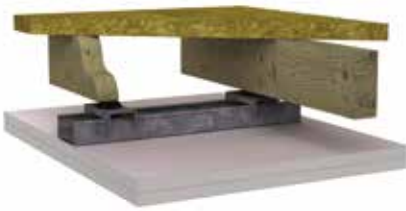
FLOOR/CEILING – TIMBER OR STEEL JOISTS WITH FURRING CHANNELS AND ACOUSTIC RESILIENT MOUNTS



**19mm TONGUE & GROOVE PARTICLEBOARD FLOORING OR BGC DURAFLOOR™ WITH FURRING CHANNELS AND ACOUSTIC RESILIENT MOUNTS - MIN CAVITY DEPTH OF 232mm**  
 Ceiling Lining 1 x 13mm GTEK™ Fire (against frame)  
 1 x 16mm GTEK™ Fire

**GTEK-C023**

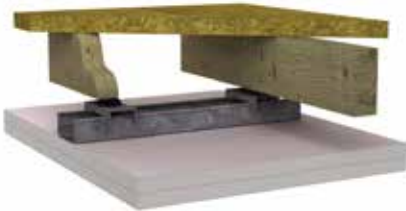
FRL	CAVITY INFILL	Rw/Rw+Ctr
		Nil
90/90/90	9kg - 50mm Glasswool	55/49
RISF 60	30kg - 75mm Glasswool	56/50



**19mm TONGUE & GROOVE PARTICLEBOARD FLOORING OR BGC DURAFLOOR™ WITH FURRING CHANNELS AND ACOUSTIC RESILIENT MOUNTS - MIN CAVITY DEPTH OF 232mm**  
 Ceiling Lining 2 x 13mm GTEK™ Fire

**GTEK-C024**

FRL	CAVITY INFILL	Rw/Rw+Ctr
		Nil
60/60/60	9kg - 50mm Glasswool	55/49
	30kg - 75mm Glasswool	56/50



**19mm TONGUE & GROOVE PARTICLEBOARD FLOORING OR BGC DURAFLOOR™ WITH FURRING CHANNELS AND ACOUSTIC RESILIENT MOUNTS - MIN CAVITY DEPTH OF 232mm**  
 Ceiling Lining 2 x 16mm GTEK™ Fire

**GTEK-C025**

FRL	CAVITY INFILL	Rw/Rw+Ctr
		Nil
90/90/90	9kg - 50mm Glasswool	56/49
RISF 60	30kg - 75mm Glasswool	56/50

ROOF/CEILING – TIMBER TRUSSES



PITCHED TILED ROOF WITH OR WITHOUT 350g/m<sup>2</sup> SARKING OR SHEETMETAL ROOF WITH MIN 50mm INSULATION OVER BATTENS – MAX JOIST OR TRUSS SPACING AT 600mm  
Ceiling Lining 1 x 10mm GTEK™ Sound

GTEK-C030

FRL	CAVITY INFILL	Rw/Rw+Ctr
		Nil
-/-/-	9kg - 50mm Glasswool	41/32
	30kg - 75mm Glasswool	42/32



PITCHED TILED ROOF WITH OR WITHOUT 350g/m<sup>2</sup> SARKING OR SHEETMETAL ROOF WITH MIN 50mm INSULATION OVER BATTENS – MAX JOIST OR TRUSS SPACING AT 600mm  
Ceiling Lining 2 x 10mm GTEK™ Sound

GTEK-C031

FRL	CAVITY INFILL	Rw/Rw+Ctr
		Nil
-/-/-	9kg - 50mm Glasswool	45/36
	30kg - 75mm Glasswool	45/37



PITCHED TILED ROOF WITH OR WITHOUT 350g/m<sup>2</sup> SARKING OR SHEETMETAL ROOF WITH MIN 50mm INSULATION OVER BATTENS – MAX JOIST OR TRUSS SPACING AT 600mm  
Ceiling Lining 1 x 13mm GTEK™ Wall

GTEK-C032

FRL	CAVITY INFILL	Rw/Rw+Ctr
		Nil
-/-/-	9kg - 50mm Glasswool	41/32
	30kg - 75mm Glasswool	42/32

ROOF/CEILING – TIMBER TRUSSES



PITCHED TILED ROOF WITH OR WITHOUT 350g/m<sup>2</sup> SARKING OR SHEETMETAL ROOF WITH MIN 50mm INSULATION OVER BATTENS – MAX JOIST OR TRUSS SPACING AT 600mm  
 Ceiling Lining 1 x 13mm GTEK™ Sound

GTEK-C033

FRL	CAVITY INFILL	Rw/Rw+Ctr
		Nil
-/-/-	9kg - 50mm Glasswool	42/34
	30kg - 75mm Glasswool	43/34



PITCHED TILED ROOF WITH OR WITHOUT 350g/m<sup>2</sup> SARKING OR SHEETMETAL ROOF WITH MIN 50mm INSULATION OVER BATTENS – MAX JOIST OR TRUSS SPACING AT 600mm  
 Ceiling Lining 2 x 13mm GTEK™ Fire

GTEK-C037

FRL	CAVITY INFILL	Rw/Rw+Ctr
		Nil
60/60/60	9kg - 50mm Glasswool	45/37
	30kg - 75mm Glasswool	46/38



PITCHED TILED ROOF WITH OR WITHOUT 350g/m<sup>2</sup> SARKING OR SHEETMETAL ROOF WITH MIN 50mm INSULATION OVER BATTENS – MAX JOIST OR TRUSS SPACING AT 600mm  
 Ceiling Lining 1 x 13mm GTEK™ Fire (against frame)  
 1 x 16mm GTEK™ Fire

GTEK-C034

FRL	CAVITY INFILL	Rw/Rw+Ctr
		Nil
90/90/90	9kg - 50mm Glasswool	46/38
RISF 60	30kg - 75mm Glasswool	47/39



ROOF/CEILING – TIMBER TRUSSES



PITCHED TILED ROOF WITH OR WITHOUT 350g/m<sup>2</sup> SARKING OR SHEETMETAL ROOF WITH MIN 50mm INSULATION OVER BATTENS – MAX JOIST OR TRUSS SPACING AT 600mm  
Ceiling Lining 2 x 16mm GTEK™ Fire

GTEK-C035

FRL	CAVITY INFILL	Rw/Rw+Ctr
	Nil	-
90/90/90	9kg - 50mm Glasswool	46/38
RISF 60	30kg - 75mm Glasswool	46/38



PITCHED TILED ROOF WITH OR WITHOUT 350g/m<sup>2</sup> SARKING OR SHEETMETAL ROOF WITH MIN 50mm INSULATION OVER BATTENS – MAX JOIST OR TRUSS SPACING AT 600mm  
Ceiling Lining 3 x 16mm GTEK™ Fire

GTEK-C036

FRL	CAVITY INFILL	Rw/Rw+Ctr
	Nil	-
120/120/120	9kg - 50mm Glasswool	48/41
RISF 120	30kg - 75mm Glasswool	48/40

ROOF/CEILING – FURRING CHANNELS



PITCHED TILED ROOF WITH OR WITHOUT 350g/m<sup>2</sup> SARKING OR SHEETMETAL ROOF WITH MIN 50mm INSULATION OVER BATTENS WITH FURRING CHANNELS  
Ceiling Lining 1 x 10mm GTEK™ Wall

GTEK-C040

FRL	CAVITY INFILL	Rw/Rw+Ctr
		Nil
-/-/-	9kg - 50mm Glasswool	40/31
	30kg - 75mm Glasswool	40/31



PITCHED TILED ROOF WITH OR WITHOUT 350g/m<sup>2</sup> SARKING OR SHEETMETAL ROOF WITH MIN 50mm INSULATION OVER BATTENS WITH FURRING CHANNELS  
Ceiling Lining 1 x 10mm GTEK™ Sound

GTEK-C041

FRL	CAVITY INFILL	Rw/Rw+Ctr
		Nil
-/-/-	9kg - 50mm Glasswool	43/34
	30kg - 75mm Glasswool	44/34



PITCHED TILED ROOF WITH OR WITHOUT 350g/m<sup>2</sup> SARKING OR SHEETMETAL ROOF WITH MIN 50mm INSULATION OVER BATTENS WITH FURRING CHANNELS  
Ceiling Lining 1 x 13mm GTEK™ Sound

GTEK-C042

FRL	CAVITY INFILL	Rw/Rw+Ctr
		Nil
-/-/-	9kg - 50mm Glasswool	44/37
	30kg - 75mm Glasswool	44/36

ROOF/CEILING – FURRING CHANNELS



PITCHED TILED ROOF WITH OR WITHOUT 350g/m<sup>2</sup> SARKING OR SHEETMETAL ROOF WITH MIN 50mm INSULATION OVER BATTENS WITH FURRING CHANNELS

Ceiling Lining 1 x 6mm BGC Duraliner™ Plus  
(Furring channels at 450 max centres)

GTEK-C043

FRL	CAVITY INFILL	Rw/Rw+Ctr
	Nil	-
-/-/-	9kg - 50mm Glasswool	41/32
	30kg - 75mm Glasswool	41/32



PITCHED TILED ROOF WITH OR WITHOUT 350g/m<sup>2</sup> SARKING OR SHEETMETAL ROOF WITH MIN 50mm INSULATION OVER BATTENS WITH FURRING CHANNELS

Ceiling Lining 1 x 13mm GTEK™ Fire (against frame)  
1 x 16mm GTEK™ Fire

GTEK-C044

FRL	CAVITY INFILL	Rw/Rw+Ctr
	Nil	-
90/90/90	9kg - 50mm Glasswool	48/41
RISF 60	30kg - 75mm Glasswool	48/41



PITCHED TILED ROOF WITH OR WITHOUT 350g/m<sup>2</sup> SARKING OR SHEETMETAL ROOF WITH MIN 50mm INSULATION OVER BATTENS WITH FURRING CHANNELS

Ceiling Lining 2 x 16mm GTEK™ Fire

GTEK-C045

FRL	CAVITY INFILL	Rw/Rw+Ctr
	Nil	-
90/90/90	9kg - 50mm Glasswool	48/41
RISF 60	30kg - 75mm Glasswool	48/41

ROOF/CEILING – FURRING CHANNELS



PITCHED TILED ROOF WITH OR WITHOUT 350g/m<sup>2</sup> SARKING  
OR SHEETMETAL ROOF WITH MIN 50mm INSULATION OVER  
BATTENS WITH FURRING CHANNELS  
Ceiling Lining 3 x 16mm GTEK™ Fire

GTEK-C046

FRL	CAVITY INFILL	Rw/Rw+Ctr
		Nil
120/120/120	9kg - 50mm Glasswool	50/42
RISF 120	30kg - 75mm Glasswool	51/43

ROOF/CEILING – FURRING CHANNELS AND ACOUSTIC RESILIENT MOUNTS



PITCHED TILED ROOF WITH OR WITHOUT 350g/m<sup>2</sup> SARKING OR SHEETMETAL ROOF WITH MIN 50mm INSULATION OVER BATTENS WITH FURRING CHANNELS AND ACOUSTIC RESILIENT MOUNTS

Ceiling Lining 1 x 10mm GTEK™ Sound

**GTEK-C050**

FRL	CAVITY INFILL	Rw/Rw+Ctr
	Nil	-
-/-/-	9kg - 50mm Glasswool	44/35
	30kg - 75mm Glasswool	45/35



PITCHED TILED ROOF WITH OR WITHOUT 350g/m<sup>2</sup> SARKING OR SHEETMETAL ROOF WITH MIN 50mm INSULATION OVER BATTENS WITH FURRING CHANNELS AND ACOUSTIC RESILIENT MOUNTS

Ceiling Lining 2 x 10mm GTEK™ Sound

**GTEK-C051**

FRL	CAVITY INFILL	Rw/Rw+Ctr
	Nil	-
90/90/90	9kg - 50mm Glasswool	49/38
RISF 60	30kg - 75mm Glasswool	50/39



PITCHED TILED ROOF WITH OR WITHOUT 350g/m<sup>2</sup> SARKING OR SHEETMETAL ROOF WITH MIN 50mm INSULATION OVER BATTENS WITH FURRING CHANNELS AND ACOUSTIC RESILIENT MOUNTS

Ceiling Lining 1 x 13mm GTEK™ Fire (against frame)  
1 x 16mm GTEK™ Fire

**GTEK-C052**

FRL	CAVITY INFILL	Rw/Rw+Ctr
	Nil	-
90/90/90	9kg - 50mm Glasswool	50/40
RISF 60	30kg - 75mm Glasswool	51/40

ROOF/CEILING – FURRING CHANNELS AND ACOUSTIC RESILIENT MOUNTS



PITCHED TILED ROOF WITH OR WITHOUT 350g/m<sup>2</sup> SARKING OR SHEETMETAL ROOF WITH MIN 50mm INSULATION OVER BATTENS WITH FURRING CHANNELS AND ACOUSTIC RESILIENT MOUNTS

Ceiling Lining 2 x 16mm GTEK™ Fire

**GTEK-C053**

FRL	CAVITY INFILL	Rw/Rw+Ctr
		Nil
90/90/90	9kg - 50mm Glasswool	50/40
RISF 60	30kg - 75mm Glasswool	52/41



PITCHED TILED ROOF WITH OR WITHOUT 350g/m<sup>2</sup> SARKING OR SHEETMETAL ROOF WITH MIN 50mm INSULATION OVER BATTENS WITH FURRING CHANNELS AND ACOUSTIC RESILIENT MOUNTS

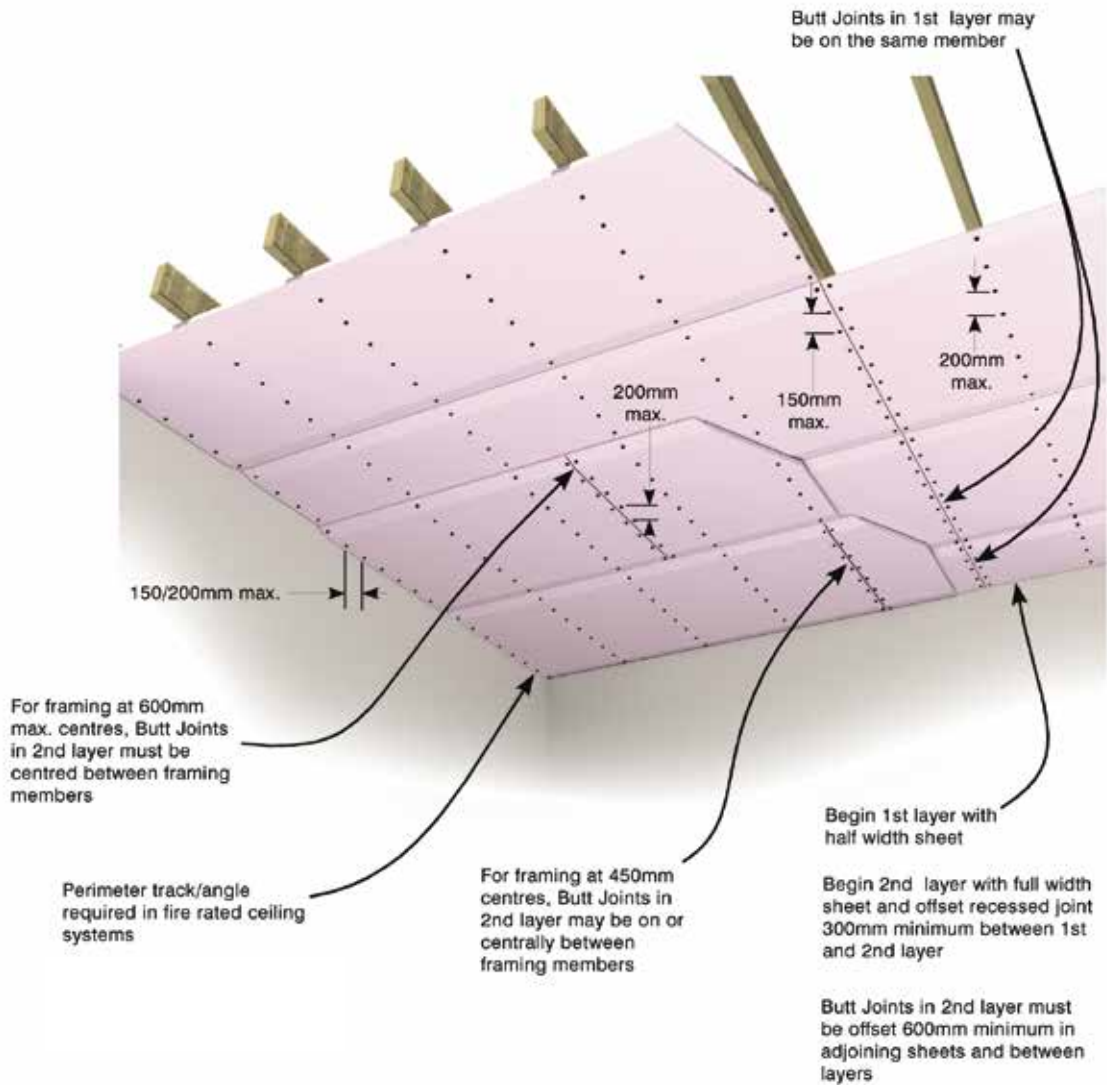
Ceiling Lining 3 x 16mm GTEK™ Fire

**GTEK-C054**

FRL	CAVITY INFILL	Rw/Rw+Ctr
		Nil
120/120/120	9kg - 50mm Glasswool	53/43
RISF 120	30kg - 75mm Glasswool	54/44

INSTALLATION DETAILS – CEILING

STEEL OR TIMBER WITH ONE OR TWO LAYERS OF GTEK™ FIRE – NAIL OR SCREW FIXING



**NOTE:**  
Final layer to be flushed and jointed.

Refer to page 15 for screw lengths.

One layer systems to be fixed as per 2nd layer. Butt joints between framing are to be fully back blocked and fixed with laminating screws.

All junctions/perimeters to be caulked with fire rated mastic

**FIXING SPECIFICATIONS ONE OR TWO LAYERS OF GTEK™ FIRE- NAIL OR SCREW FIXING**  
**FIRST LAYER**

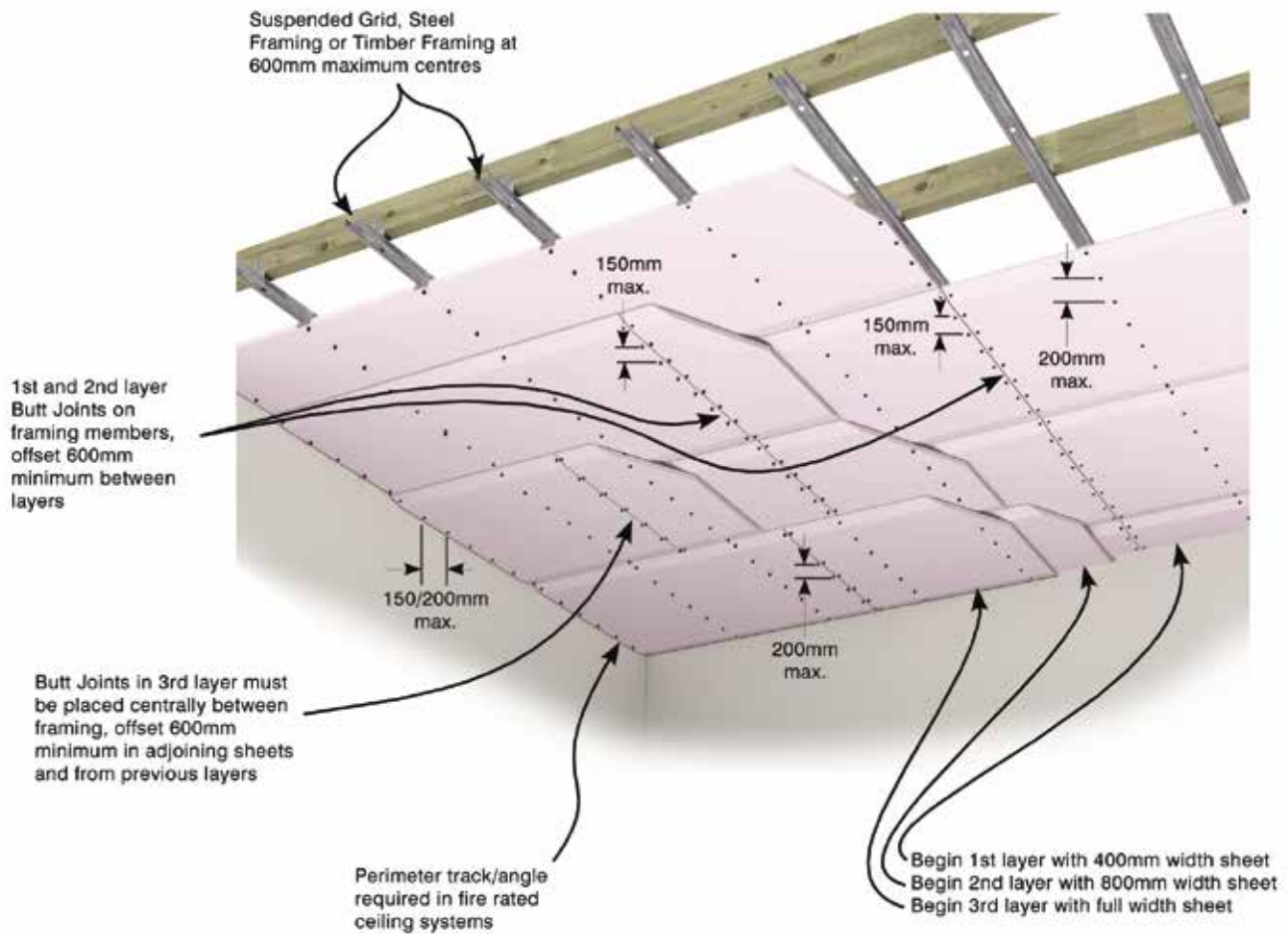
FASTENER SPACING	LOCATION
Each framing member at 10 to 16mm from sheet edges and at 200mm max centres	Centre of the Board
150mm max centres	Butt Joints
150mm max centres	Openings
150mm max centres	Sheet ends

**SECOND LAYER**

Framing at 450mm - 150mm max centres Framing at 600mm - within 50mm of centre line between framing & fix to 1st layer with laminating screws at 200mm max centres	Butt Joints
150mm max centres	Openings
150mm max centres	Sheet ends

INSTALLATION DETAILS – CEILING

STEEL OR TIMBER WITH THREE LAYERS OF GTEK™ FIRE – NAIL OR SCREW FIXING



**NOTE:**  
Final layer to be flushed and jointed.

Refer to page 15 for screw lengths.

All junctions/perimeters to be caulked with fire rated mastic

**FIXING SPECIFICATIONS THREE OF GTEK™ FIRE - NAIL OR SCREW FIXING**

**FIRST LAYER**

FASTENER SPACING	LOCATION
	Centre of the Board
150mm max centres	Butt Joints
150mm max centres	Openings
150mm max centres	Sheet ends

**SECOND LAYER**

Each framing member at 10 to 16mm from sheet edges and at 200mm max centres	Centre of the Board
150mm max centres	Butt Joints
150mm max centres	Openings
150mm max centres	Sheet ends

**THIRD LAYER**

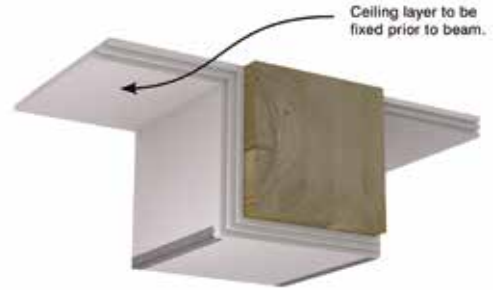
Each framing member at 10 to 16mm from sheet edges and at 200mm max centres	Centre of the Board
Within 50mm of centre line between framing & fix to previous layer with laminating screws at 200mm max centres	Butt Joints
150mm max centres	Openings
150mm max centres	Sheet ends



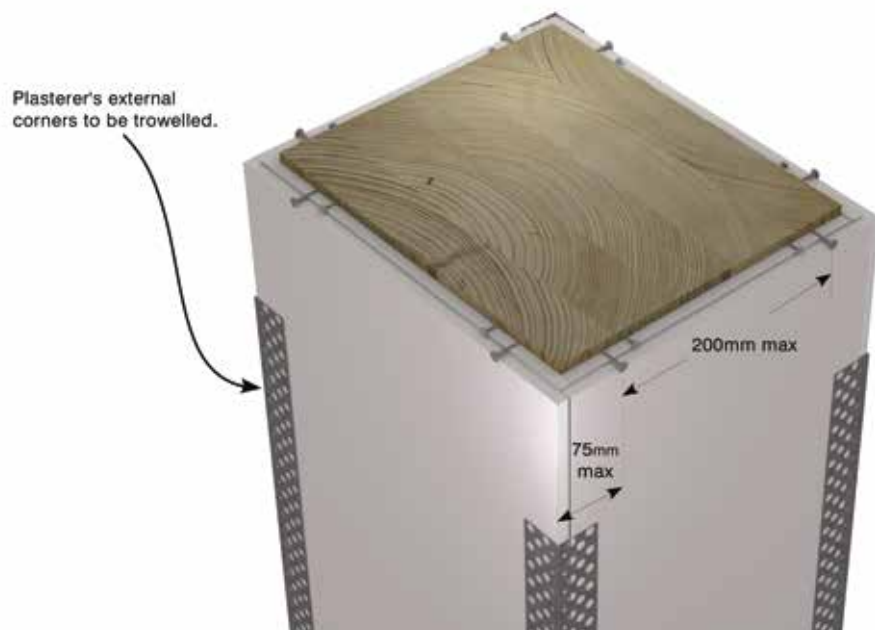
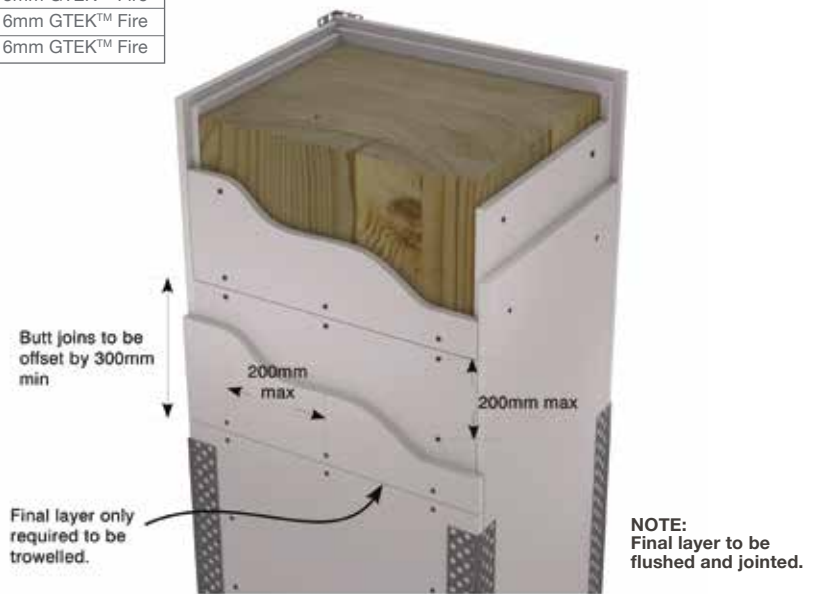
COLUMN OR BEAM

STEEL OR TIMBER WITH ONE OR TWO LAYERS OF GTEK™ FIRE – NAIL OR SCREW FIXING

- Steel angle fixed to the soffit or wall junction.
- Universal Encasement Clips friction fitted to the remaining column/beam flanges.
- Wall Furring Track is held in the back tongue of the clip.
- Noggings at each end of the column/beam and behind plasterboard butt joins in single layer systems.

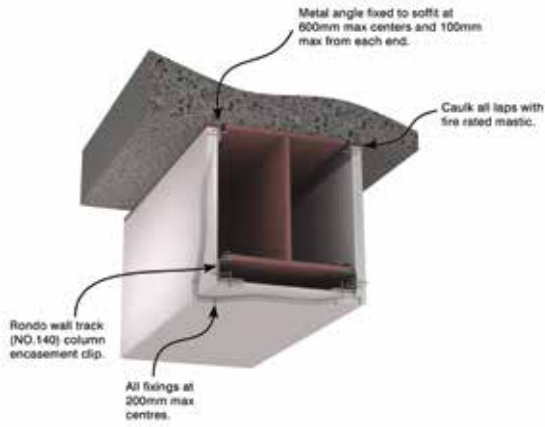


FRL	SYSTEM NO.	LININGS
30/-/-	GTEK-CB01	1 x 13mm GTEK™ Fire
60/-/-	GTEK-CB02	2 x 13mm GTEK™ Fire
90/-/-	GTEK-CB03	2 x 16mm GTEK™ Fire
90/-/-	GTEK-CB04	3 x 13mm GTEK™ Fire
120/-/-	GTEK-CB05	3 x 16mm GTEK™ Fire
180/-/-	GTEK-CB06	4 x 16mm GTEK™ Fire

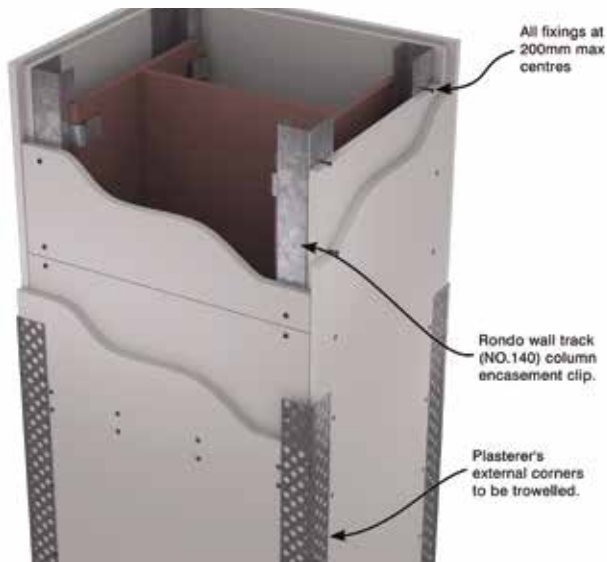


COLUMN OR BEAM

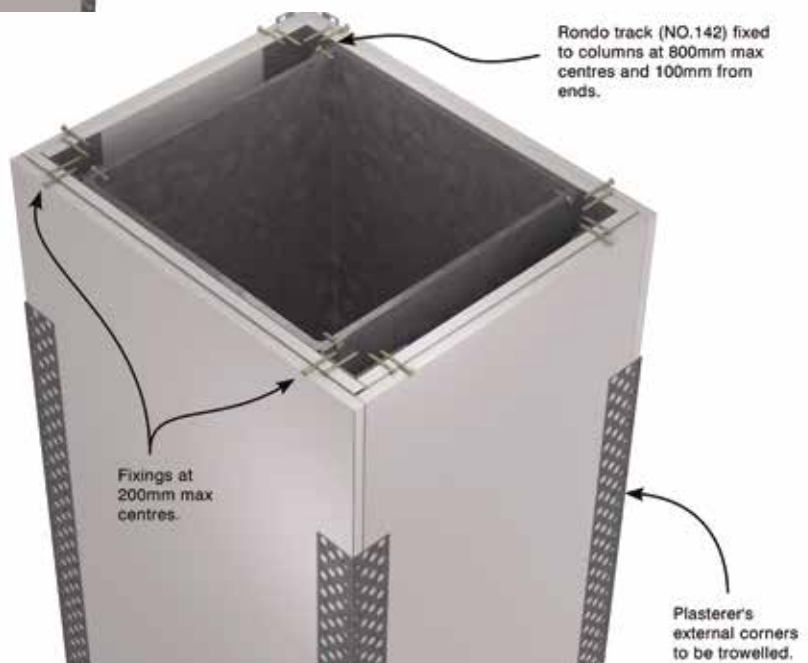
STEEL OR TIMBER WITH ONE OR TWO LAYERS OF GTEK™ FIRE – NAIL OR SCREW – FIXING



FRL	SYSTEM NO.	LININGS
30/-/-	GTEK-CB07	1 x 13mm GTEK™ Fire
60/-/-	GTEK-CB08	2 x 13mm GTEK™ Fire
90/-/-	GTEK-CB09	2 x 16mm GTEK™ Fire
120/-/-	GTEK-CB10	3 x 16mm GTEK™ Fire
180/-/-	GTEK-CB11	4 x 16mm GTEK™ Fire
120/-/-	GTEK-CB12	3 x 13mm GTEK™ Fire



**NOTE:**  
Final layer to be flushed and jointed.

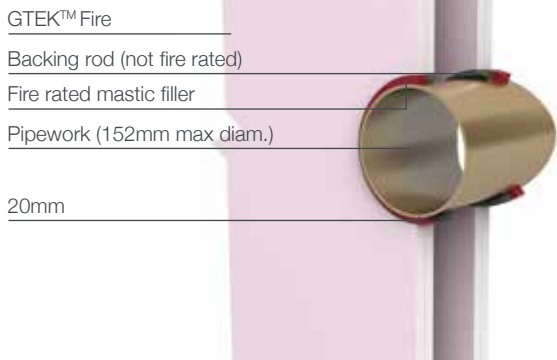


PENETRATIONS – TYPICAL

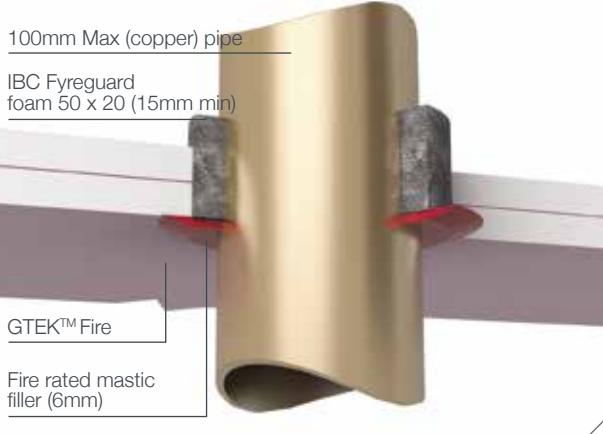
Special design considerations apply to Fire Rated walls in order to maintain the Fire Rating (FRL) of a system.

- Electrical penetrations must not be placed back to back or more than one penetration per stud spacing.
- Proprietary Fire Rated switch boxes are to be used.
- BGC Plasterboard recommends the use of min R1.5 insulation batt be included in the wall cavity to assist in maintaining acoustic integrity.
- All penetrations shall be sealed with an approved AS/NZS 1530.4 Fire Rated mastic filler. See Figure 1.
- Where plumbing penetrations are required all pipe-work must be self supporting.

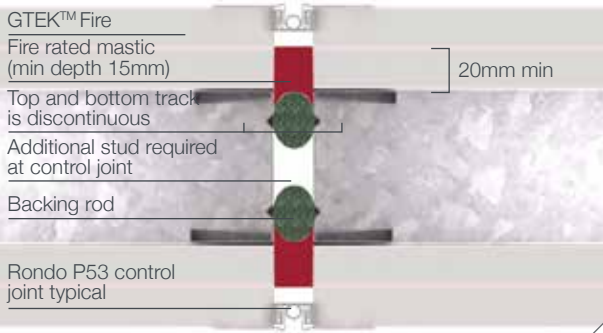
**FIGURE 1 – PIPE PENETRATION THROUGH WALL (COPPER)**



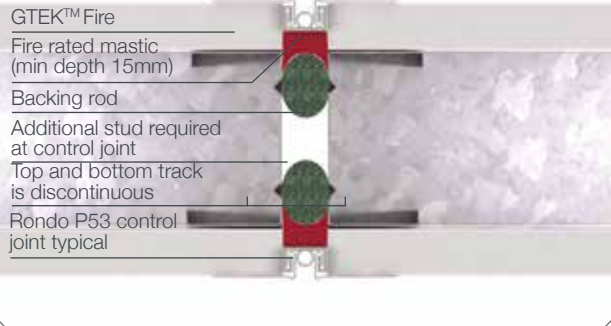
**FIGURE 2 – PIPE PENETRATION THROUGH CEILING**



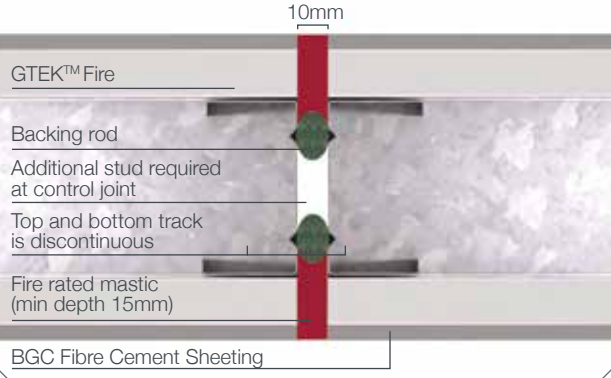
**FIGURE 3 – CONTROL JOINT - WALL FRAME DOUBLE LAYER**



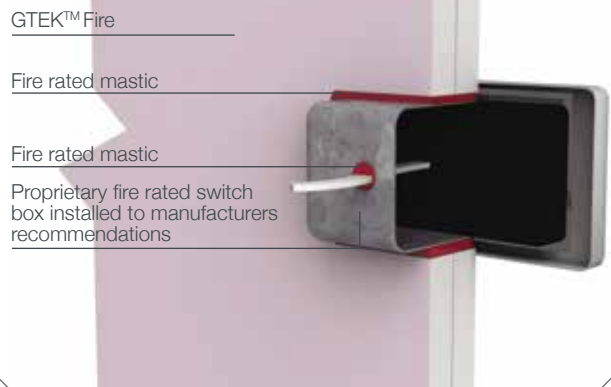
**FIGURE 4 – CONTROL JOINT - WALL FRAME SINGLE LAYER**



**FIGURE 5 – CONTROL JOINT - WALL FRAME**

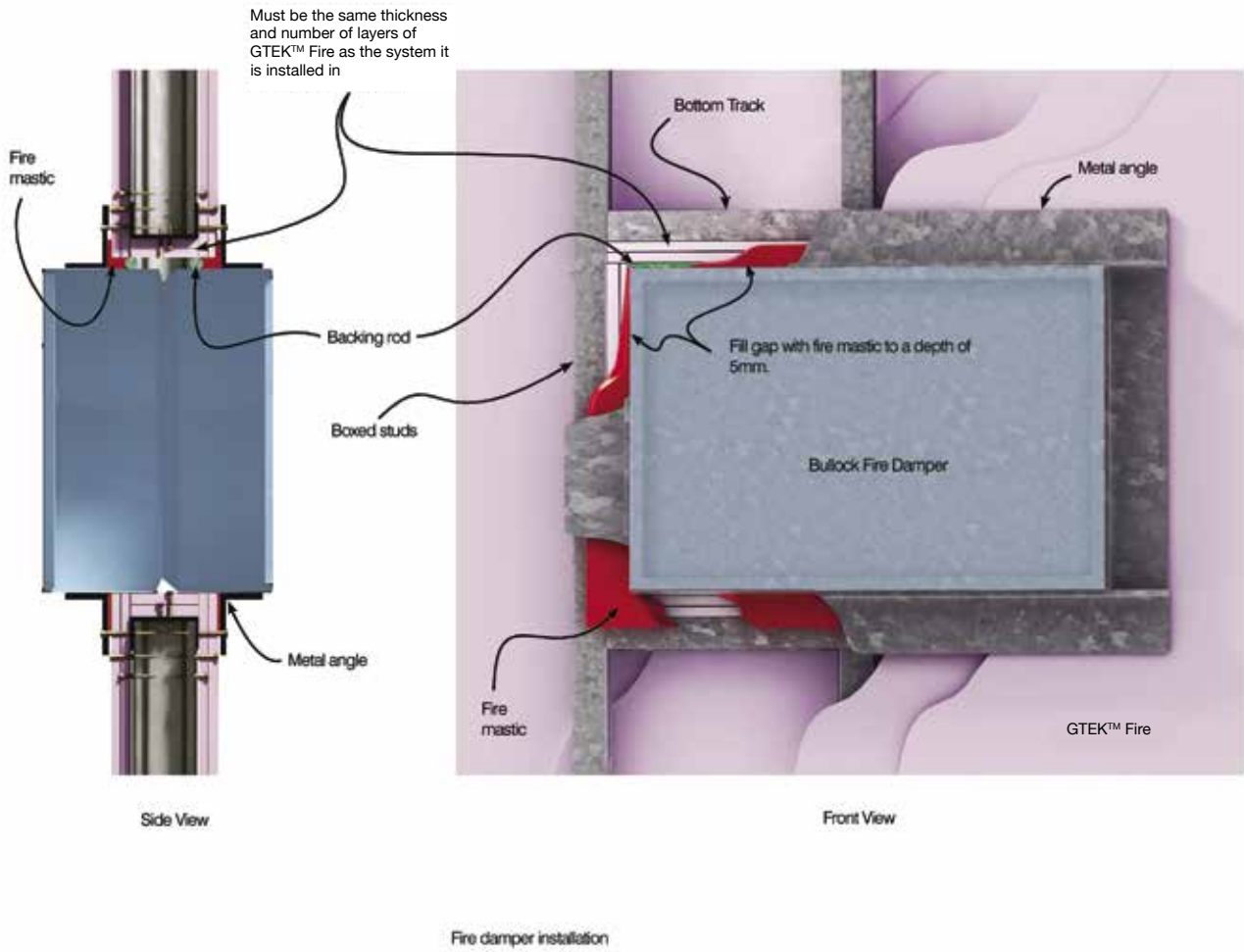


**FIGURE 6 – ELECTRICAL PENETRATION THROUGH WALL (TYPICAL). Note: Do not place switch boxes back to back.**



PENETRATIONS – TYPICAL

FIRE PENETRATIONS FOR SINGLE, DOUBLE & STAGGERED STUD WALLS - ELEVATION



## WARRANTY

We warrant that our products are free from defects caused by faulty manufacture or materials for a period of 15 years from the date of purchase. If you acquire any defective products, we will repair or replace them, supply equivalent replacement products or refund the purchase price within 30 days of receiving a valid claim subject to product inspection and confirmation of the existence of a defect by BGC. We will bear the cost of any such repair, replacement or refund.

This warranty is given by:

**BGC PLASTERBOARD PTY LTD**

Ground Floor, 290 Bushmead Rd,  
Hazelmere, WA 6055 Phone: (08) 9374 2900  
Fax: (08) 9374 2901

To claim under this warranty, you must provide proof of purchase as a consumer and make a written claim (including any costs of claiming) to us at the address specified above within 30 days after the defect was reasonably apparent, or if the defect was reasonably apparent prior to installation, the claim must be made prior to installation. You may not claim under this warranty for loss or damage caused by:

- ▶ faulty or incorrect installation by non-BGC installers (BGC's installation procedures are at gtekplasterboard.com.au.com.au);
- ▶ failure to comply with the Building Code of Australia or any applicable legislation, regulations approvals and standards;
- ▶ products not made or supplied by BGC;
- ▶ abnormal use of the product; or
- ▶ normal wear and tear.

The benefits available under this warranty are in addition to other rights and remedies of the consumer under the law. Our goods come with guarantees that cannot be excluded under the Australian Consumer Law. You are entitled to a replacement or refund for a major failure and for compensation for any other reasonably foreseeable loss or damage. You are also entitled to have the goods repaired or replaced if the goods fail to be of acceptable quality and the failure does not amount to a major failure.

NOTES

A series of horizontal dashed lines for taking notes.

NOTES

NOTES

Area with horizontal dashed lines for taking notes.

NOTES

▶ PAGE 125

NOTES

NOTES

A large area of the page is filled with horizontal dashed lines, providing a space for handwritten notes.



NOTES

Lined area for taking notes, consisting of multiple horizontal dashed lines.

NOTES

## CONTACT

TO CONTACT  
YOUR NEAREST  
BGC STOCKIST,  
PLEASE CALL:

**ADELAIDE**  
TELEPHONE  
08 8250 4962

**BRISBANE**  
TELEPHONE  
07 3271 1711

**MELBOURNE**  
TELEPHONE  
03 9392 9444

**PERTH**  
TELEPHONE  
08 9374 2900

**SYDNEY**  
TELEPHONE  
02 9771 9660

**NEW ZEALAND**  
TELEPHONE  
0011 64 9273 1457

**TECHNICAL HELP LINE**  
1300 652 242



Quality  
ISO 9001

SAI GLOBAL



BGC-2014  
GECA 04-2011 v2  
Panel Boards

**BGC**

Plasterboard

CONTACT

TO CONTACT  
YOUR NEAREST  
BGC STOCKIST,  
PLEASE CALL:

**ADELAIDE**  
TELEPHONE  
08 8480 1700

**BRISBANE**  
TELEPHONE  
07 3548 8400

**MELBOURNE**  
TELEPHONE  
03 9492 1700

**PERTH**  
TELEPHONE  
08 9374 2900

**SYDNEY**  
TELEPHONE  
02 8107 9500

**NEW ZEALAND**  
TELEPHONE  
0011 64 9273 1457

**TECHNICAL HELP LINE**  
1300 652 242



Quality  
ISO 9001  
SAI GLOBAL



**BGC** | Plasterboard

